

OPERATION MANUAL

MV-1600

Multi Viewer



S

2nd Edition



Precautions

Important Safety Warnings



[Power]

 Caution	Operate the unit at the specified supply voltage only .
	Unplug the power cord by pulling the plug only. Do not pull on the cable.
 Stop	Do not place or drop heavy or sharp-edged objects on the power cord. A damaged cord can cause a fire or electrical shock. Regularly check the power cord for excessive wear or damage to prevent possible fire or electrical hazards.

[Grounding]

 Caution	Ensure the unit is properly grounded at all times to prevent electrical shock.
 Hazard	Do not ground the unit to gas lines, units, or fixtures of an explosive or dangerous nature.
 Caution	Ensure the power cord is firmly plugged into an AC outlet.



[Operation]

 Hazard	Do not operate the unit in hazardous or potentially explosive environments. Doing so could result in a fire, explosion, or other accident.
 Hazard	Do not allow liquids, metal pieces, or other foreign objects to get inside the unit. Doing so could result in a fire or other hazard, or malfunction.
	If a foreign object gets inside the unit, turn the power off and disconnect the power cord immediately . Remove the foreign object, and then contact your authorized service representative if damage has occurred.

[Transportation]

 Caution	Handle with care to avoid shocks in transit. Shocks may cause a malfunction. When you need to transport the unit, use the original packing materials or equivalent packing.
--	--

[Circuitry Access]

 Stop	<p>Do not remove any covers, panels, casing, or access circuitry while the power to the unit is on! Turn the power off and disconnect the power cord prior to removing any parts. Internal servicing and adjustment of the unit should be performed by qualified personnel only.</p>
 Stop	<p>Do not touch any parts or circuitry with a high heat factor. Capacitors can retain enough electric charge to cause a mild to serious shock even after the power is disconnected. Capacitors associated with the power supply are especially hazardous. Avoid contact with any capacitors.</p>
 Hazard	<p>The unit should not be operated or stored with the cover, panels, or casing removed. Operating the unit with the circuitry exposed could result in electric shock, fire, or a malfunction.</p>

[Potential Hazards]

 Caution	<p>If the unit emits any abnormal smells or noises, immediately turn the power off and disconnect the power cord to avoid a potentially hazardous situation. If this problem occurs, contact your authorized service representative before attempting to operate the unit again.</p>
--	---

[Consumables]

 Caution	<p>The consumables used in unit must be replaced periodically. For further details on which parts are consumables and when they should be replaced, refer to the specifications at the end of the Operation Manual. Since the service life of the consumables varies greatly depending on the environment in which they are used, they should be replaced at an early date. For details on replacing the consumables, contact your dealer.</p>
--	--

[Rubber Feet]

 Caution	<p>If this product includes rubber feet attached by screws, when the rubber feet and screws are removed, do not reinsert the screws without the rubber feet. Doing so could cause damage to the internal circuits or components of the unit. Also, when reinstalling the rubber feet to the unit, use only the supplied rubber feet and screws.</p>
--	---

Upon Receipt

Unpacking

The MV-1600 units and their accessories are fully inspected and adjusted prior to shipment. Operation can be performed immediately upon completing all required connections and operational settings.

Check your received items against the packing lists below.

ITEM	QTY	REMARKS
MV-1600	1	
AC Cable	1	
Rack mount bracket	2	
Rubber feet	4	
Remote Control Software	1	CD-ROM
Operation Manual	1 set	One for main unit. One for software.

Check

Check to ensure no damage has occurred during shipment. If damage has occurred, or items are missing, inform your supplier immediately.

目次

1. Prior to Starting.....	1
1-1. Welcome	1
1-2. Features	1
1-3. About This Manual.....	2
2. Panel Descriptions	3
2-1. Front Panel.....	3
2-2. Rear Panel	5
3. Connection	6
3-1. System with SXGA Output	6
3-2. System with Video Transmission.....	6
3-3. System with SXGA and Video Transmission	7
3-4. Network Options.....	8
3-4-1. UNICAST Mode.....	8
3-4-2. MULTICAST Mode	8
4. Operation	9
4-1. Operation at Startup	9
4-2. Initialization	9
4-3. Modifying SXGA Output Timing.....	10
4-4. Displaying Full Screen.....	11
4-5. Displaying Split Screens.....	12
4-6. Selecting Split Screen Pages	13
4-7. Auto Sequencing Mode	14
4-7-1. Full Screen Auto Sequencing	14
4-7-2. Quad and 9-split Screen Auto Sequencing.....	14
4-8. External Alarm and Video Loss Display.....	15
4-8-1. Full Screen Setting	15
4-8-2. Split Screen Setting	17
4-8-3. Clearing Alarm or Video Loss Alarm Status	18
5. Menu Operations.....	19
5-1. Main Menu Display.....	19
5-2. TIME SETUP (Time Settings).....	21
5-2-1. Auto Sequencing Interval Settings.....	22
5-3. ALARM/VIDEO LOSS (Alarm and Video Loss Settings)	23
5-4. TITLE (Camera Title Settings).....	25
5-4-1. TITLE SET (SXGA·VIDEO)	26
5-5. DISPLAY (Screen Display Settings).....	28
5-6. LAN (LAN Settings).....	30

5-7. SYSTEM (System Settings).....	32
6. REMOTE / ALARM Interface	34
6-1. Connector Pin Assignments.....	34
6-2. REMOTE Interface.....	35
6-3. ALARM Interface.....	37
6-4. FAN ALARM Output.....	37
6-5. RS-232C Interface	38
6-5-1. RS-232C Connector.....	38
6-5-2. Cable Connection Example	38
6-5-3. Communication Standard.....	38
7. LAN Interface.....	39
7-1. LAN Connector	39
7-2. Ethernet Communication Standard	39
8. Troubleshooting	40
9. Specifications and Dimensions	41
9-1. Specifications.....	41
9-2. External Dimensions.....	43

1. Prior to Starting

1-1. Welcome

Congratulations! By purchasing MV-1600 Multi Viewer, you have entered the world of FOR-A and its many innovative products. Thank you for your patronage, and we hope you will turn to FOR-A products again and again to satisfy your video and audio needs.

FOR-A provides a wide range of products, from basic support units to complex system controllers, which have been increasingly joined by products for computer video based systems. Whatever your needs, talk to your FOR-A representative. We will do our best to be of continuing service to you.

1-2. Features

The MV-1600 is the 16-split multi viewer that accepts asynchronous color or B/W video signals from up to 16 cameras, reformatting the images for display on a single screen.

Monitor output includes two analog composite video outputs and one analog RGB SXGA output. SXGA output enables Quad screen monitoring at a higher resolution than conventional multi viewers with virtually no size reduction of the video from each camera.

The video transmission over a network is also possible for easily expanding the existing analog video monitoring system to a remote monitoring system. Moreover, it has a multicast function which enables simultaneous display on multiple PC monitors.

In addition to in-store monitoring, the MV-1600 supports a wide range of other monitoring applications in banks, hotels, amusement parks, theaters, and production lines.

- Capable of using in mixed system of asynchronous, color or B/W signals
- Easy system expansion using input loopthrough
- Monitor output includes SXGA high-resolution output in addition to analog composite output
- Two analog composite output lines. Screen display can be selected from full screen, quad screen and 16-split screen
- SXGA display can be selected from full screen, quad screen, 9-split screen and 16-split screen
- Video transmission function with maximum frame rate of 60 fps (when using the MV-1600 Live Viewer software) * A frame rate of 60 fps may not be obtained due to the conditions of transferred video signal, JPEG compression ratio, connected PC, or network environment.
- Selectable two types of network modes: unicast and multicast
- Automatic channel switching function (in full screen and split screen)
- Built-in input/output connector for external alarm enables linking of display to alarm system
- Parallel remote connection. Control over a RS-232C interface is supported
- Supports control over a LAN (100BASE-TX) interface
- Supports display of titles up to 8 characters on SXGA output and up to 6 characters on analog composite outputs for each camera (alphanumeric characters, Japanese kana, symbols)

1-3. About This Manual

This manual is intended to help the user easily operate this MV-1600 and make full use of its functions during operation. Before connecting or operating your MV-1600, read this operation manual thoroughly to ensure you understand the product. After reading, keep this manual in a safe place and available for reference.

Font Conventions

The following conventions are used throughout this manual:

- Text enclosed by a square (such as `ENTER`) indicates **buttons on operation panel**.
- Text enclosed by square brackets (such as `[Exit]`) indicates **menu items**.

2. Panel Descriptions

2-1. Front Panel

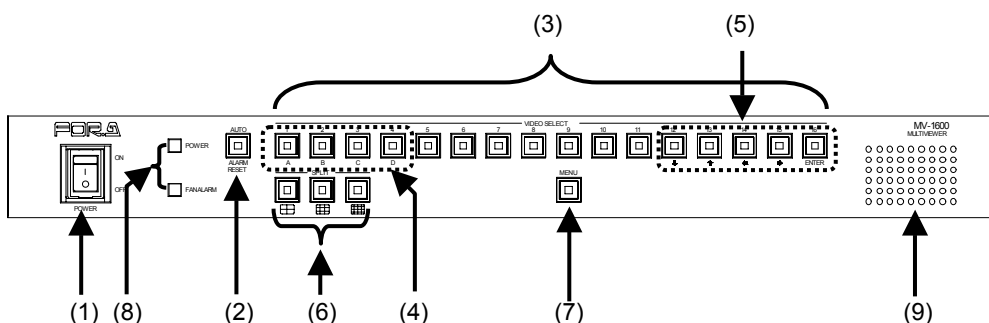

- (1) POWER switch
Used to turn the unit power ON/OFF.

IMPORTANT
When powered on, the MV-1600 attempts to pick the video standard (NTSC or PAL) automatically based on the input signal it receives. If there is no video input, it selects the video standard that is selected at the previous startup.
Using NTSC and PAL at the same time is not supported. Be sure not to use different formats together. It may cause malfunctions.

- (2) AUTO/ALARM RESET
- AUTO: When this button is pressed and lamp is lit, automatic channel switching is performed in full screen display, or automatic page switching is performed in quad and 9-split screen display.
- ALARM RESET: The button flashes when an external alarm signal is received or video loss occurs (when the image is cut). Press this button to clear the alarm.

IMPORTANT
External alarms cannot be cleared when LEVEL is chosen for ALARM INPUT. (See section 5-3. "ALARM/VIDEO LOSS".)

- (3) SELECT 1 - 16 (Camera select buttons)
Used to select a camera input for full screen display.
- (4) A, B, C, D
Used to select a assigned page for split screen display. (See section 4-6. "Selecting Split Screen Pages")
- (5)  ENTER
Used to navigate the Menu screen.

(6) SPLIT (Split Display Button)

Used to select the split display mode.

(7) MENU (Menu button)

Used to start menu mode. In menu mode, this button is also used to return to the previous menu screen or to exit menu mode.

* To display the menu, press and hold the MENU button for about 2 seconds.

(8) Power indicator: The Power indicator will be lit green when power switch is set to ON and power is supplied to the unit.

FAN ALARM indicator: The Fan Alarm indicator will be lit red when the fan is stopped.

(9) Fan (Front)

Used to air cool the unit to prevent overheating. The air flows from the front to the side. Do not block the fan vent with an object.

2-2. Rear Panel

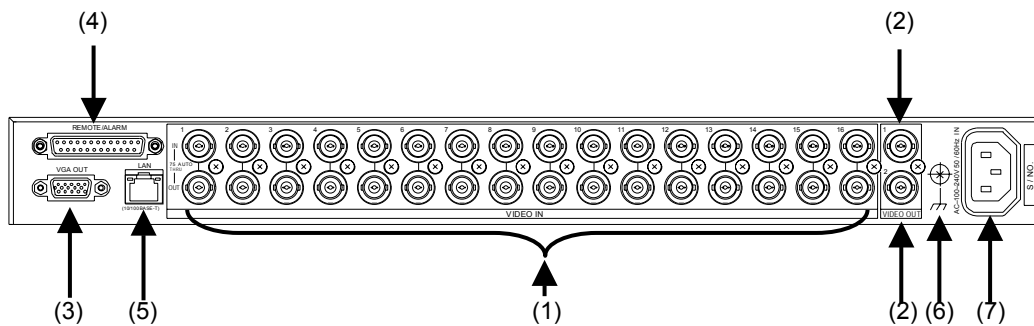

(1) VIDEO IN 1 - 16

The top connectors are used to input video signals. To loop through the signals to other devices, connect to the bottom connectors. The bottom connectors are automatically terminated when not connected.

(2) VIDEO OUT 1/2

Each connector is used to output an analog composite signal to a monitor. The full or split screen display can be selected by the button on the front panel or by the control from external device.

(3) VGA OUT

Used for analog RGB monitor output connection. Connect SXGA (1280 x 1024 pixel 60 Hz) monitor.

IMPORTANT

To use SXGA output, select SXGA or SXGA & NETWORK in the FUNCTION menu. See section 5-7. "SYSTEM (System Settings)" for details.

(4) REMOTE/ALARM

Used for either the external control connection (remote unit or RS-232C interface) or the alarm input connection.

(5) LAN (10/100BASE-T)

LAN interface (Ethernet) used for remote control by computer. This can be also used for video output to the computer over a LAN interface.

IMPORTANT

To output video to a computer, select NETWORK or SXGA & NETWORK in the FUNCTION menu. See section 5-7. "SYSTEM (System Settings)" for details.

(6) Ground Terminal

Used to ground the unit to protect operators against static electricity and electrical shock.

(7) AC IN (100-240V AC 50/60Hz)

Used for connecting to an AC power source using the supplied accessory cord.

3. Connection

3-1. System with SXGA Output

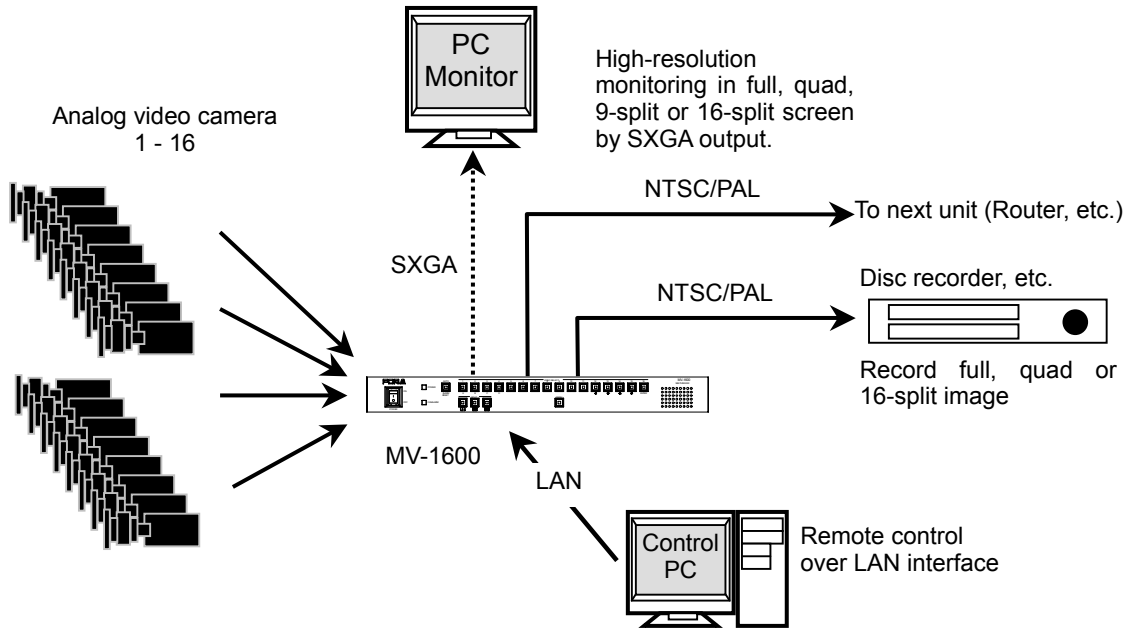

IMPORTANT

To connect a PC and MV-400 directly, use a crossover LAN cable. If you are connecting PC and MV-400 through a hub or such device, use a straight LAN cable.

3-2. System with Video Transmission

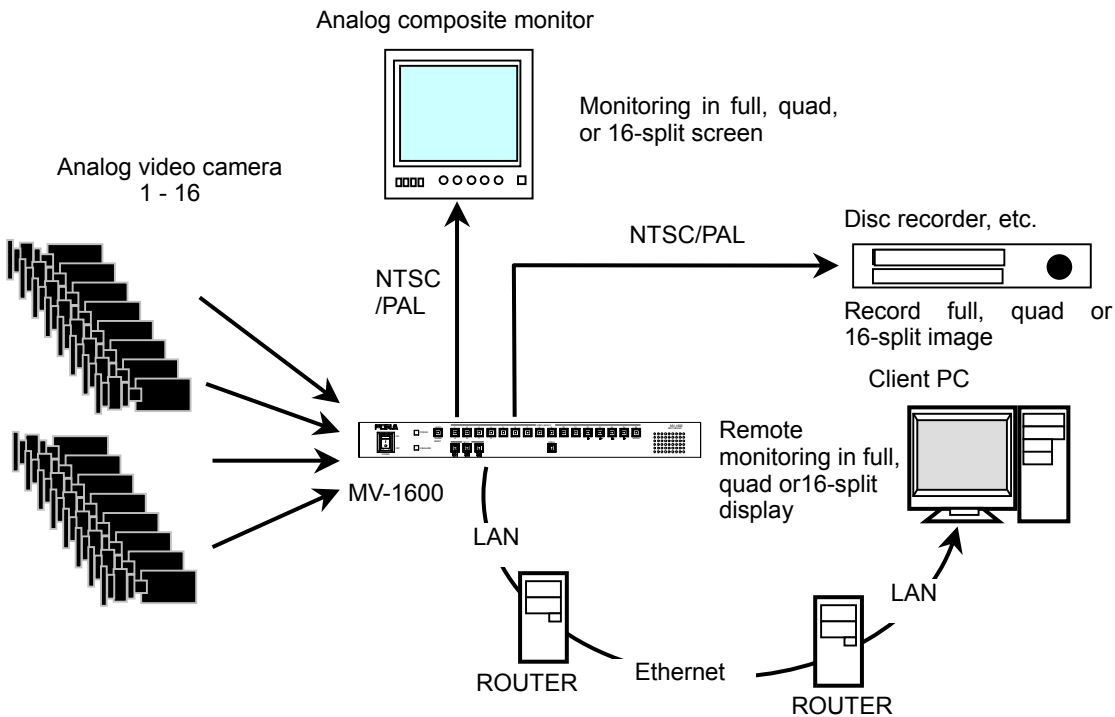

3-3. System with SXGA and Video Transmission

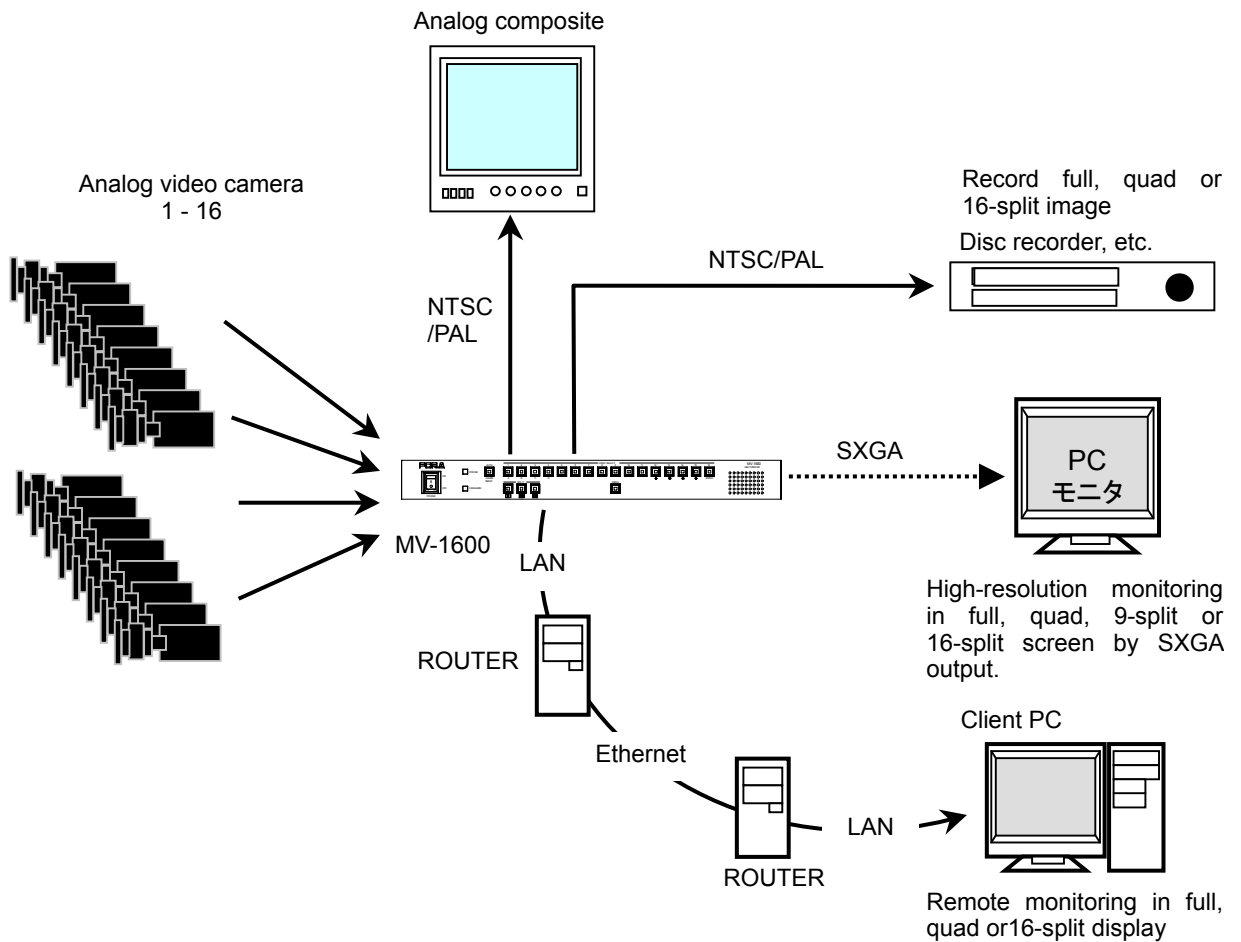

IMPORTANT

When both the SXGA output and the video transmission to a computer are used at the same time, refresh rate of the SXGA display drops to about a half the rate of using the SXGA alone. Refresh rate of the video transmission also drops compared to the rate of using the video transmission alone.

The display screen settings are shared by SXGA output, VIDEO output and the video transmission over a LAN interface. See section 4-5. "Displaying Split Screens" for the detail on display screen settings.

3-4. Network Options

There are two network modes for video transmission. The UNICAST mode and the MULTICAST mode. See section 5-7. "SYSTEM (System Settings)" for the setting procedures.

3-4-1. UNICAST Mode

The UNICAST mode uses TCP/IP protocol and the video output can be displayed on one PC by using MV-1600 Live Viewer.

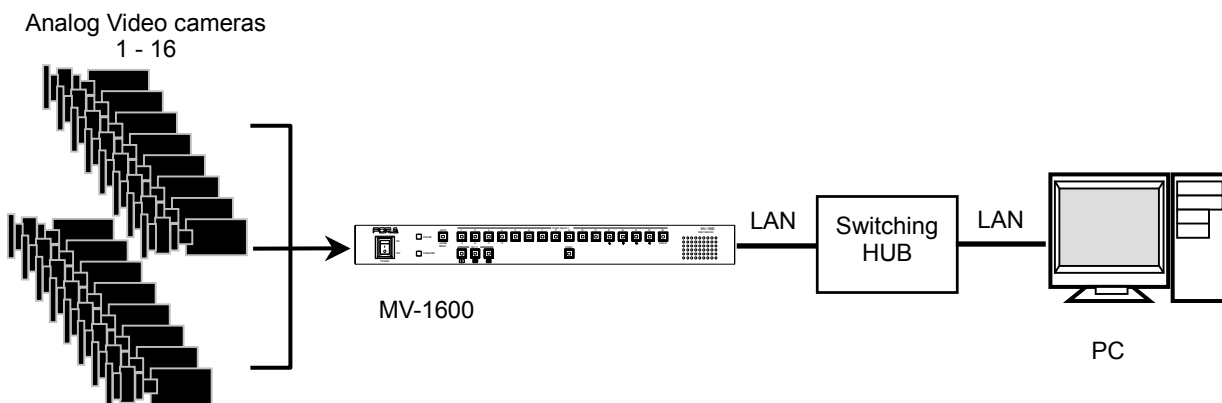

3-4-2. MULTICAST Mode

The MULTICAST mode uses the IP multicast and that enables you to output video to multiple PCs.

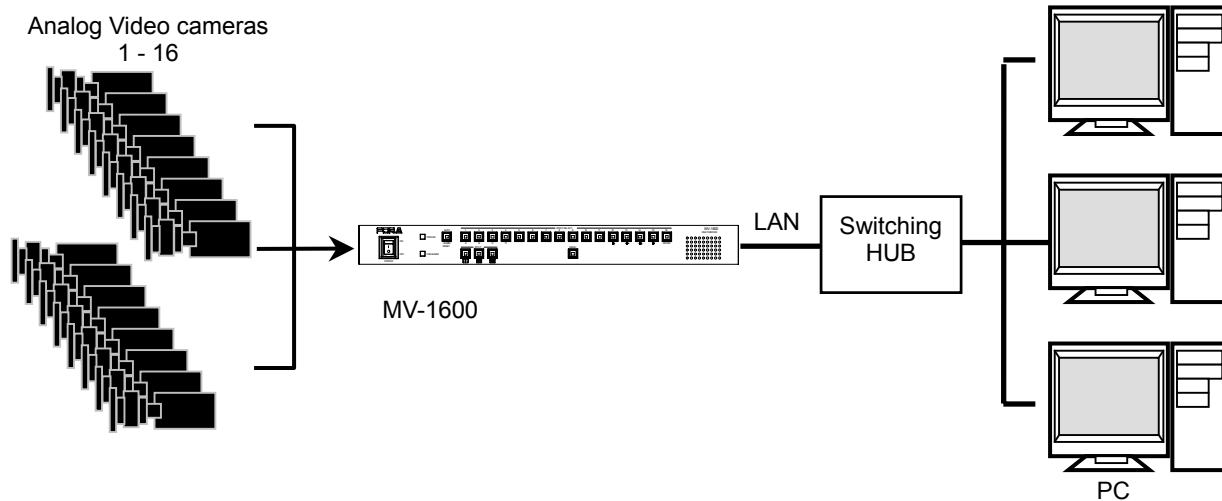

IMPORTANT

The MV-1600 Live Viewer cannot control video output in the MULTICAST mode. To control the output video, use the VIEWER screen of Internet Explorer.

This network uses the UDP protocol. Due to the UDP protocol, the image refreshment may get disturbed at the packet loss which occurs under the unstable network condition.

4. Operation

4-1. Operation at Startup

After the power is turned on, operation resumes from the last screen before it was turned off. If a menu is displayed when the unit was turned off, operation resumes from the previous mode.

4-2. Initialization

Although initialization is not normally required, you can restore the MV-1600 to the factory settings when the previous data is no longer needed such as after relocation or system modification. Turn the power on while holding down the **AUTO** button to initialize the data settings.

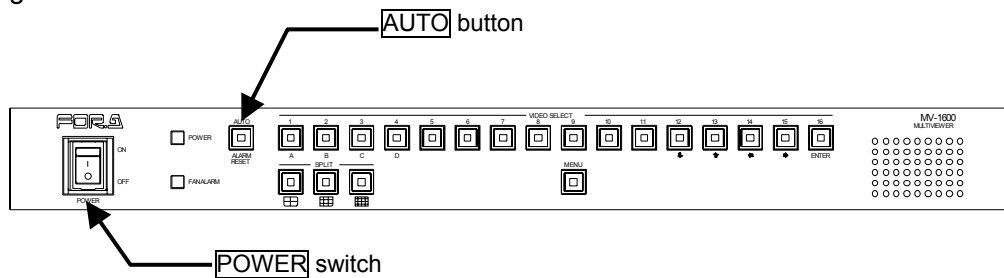

4-3. Modifying SXGA Output Timing

It is not required in the usual operation, however, it is possible to adjust output timing for the connected SXGA monitor.

Turn the power on while pressing **MENU** button to open SXGA SETUP screen.

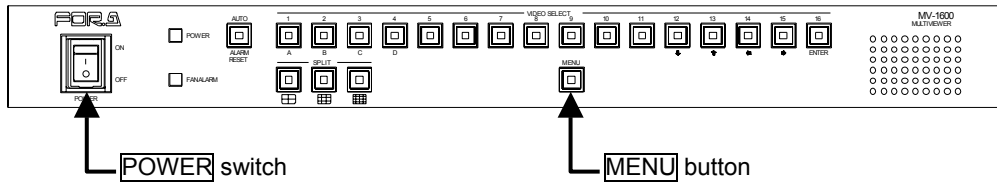

The SXGA SETUP screen shown below is displayed.

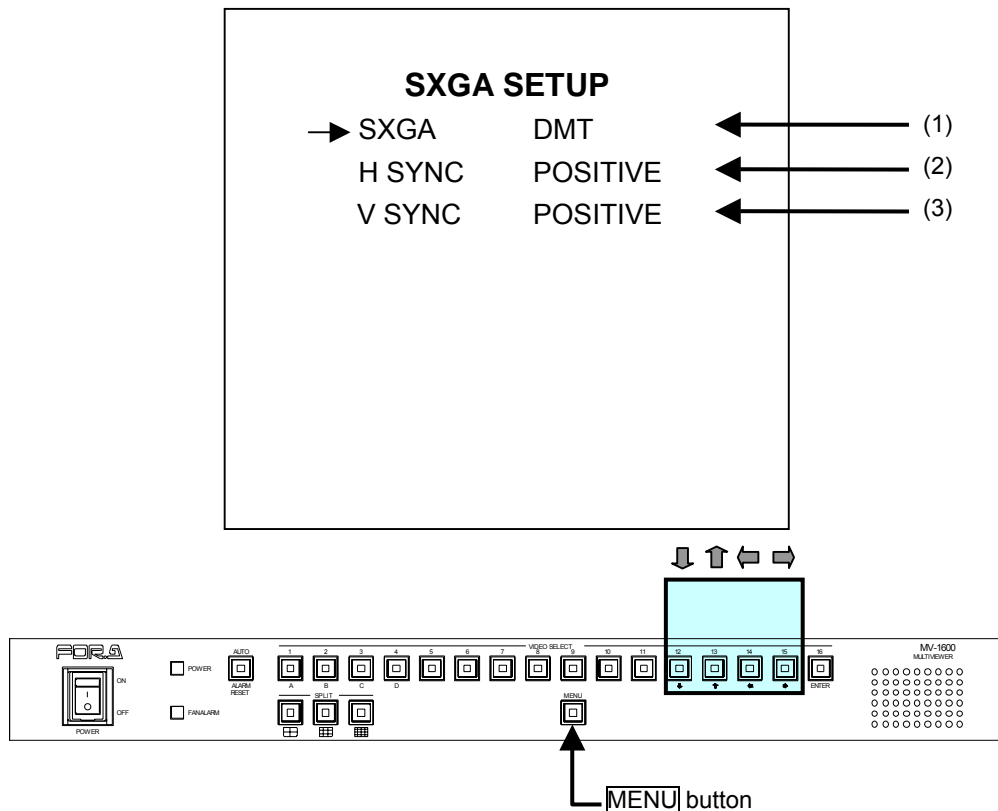

◆ Operation Procedure

Button	Action
↓	Moves the cursor down.
↑	Moves the cursor up.
←	Changes the setting item value. (Reverse)
→	Changes the setting item value. (Forward)
MENU	Exits the SXGA SETUP screen.

◆ Setting Item

Item	Description	
(1) SXGA	Changes SXGA output timing standards.	
	DMT	Horizontal frequency: 64.0kHz Vertical frequency: 60.0Hz
	CVT	Horizontal frequency: 63.7kHz Vertical frequency: 59.9Hz
	GTF	Horizontal frequency: 63.6kHz Vertical frequency: 60.0Hz
(2) H SYNC	POSITIVE	H-sync polarity: Positive
	NEGATIVE	H-sync polarity: Negative
(3) V SYNC	POSITIVE	V-sync polarity: Positive
	NEGATIVE	V-sync polarity: Negative

IMPORTANT

The SXGA SETUP setting is applied when the MV-1600 is turned on. Whenever the settings are modified, make sure to close the SXGA SETUP screen by pressing MENU button, turn the MV-1600 power off and reapply the power to the unit.

4-4. Displaying Full Screen

To display your desired channel in a full screen, use SELECT **[1]** to **[16]** buttons. For instance, to view channel 3, press the SELECT **[3]** button to display the video in full screen.

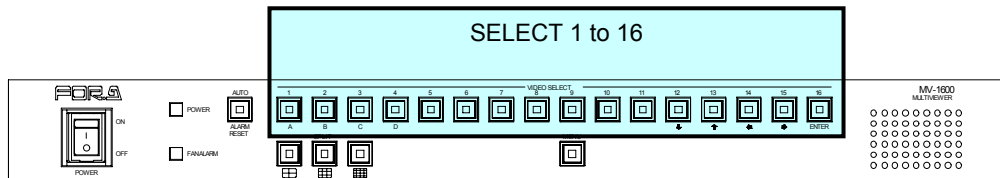

IMPORTANT

A black screen is shown for channels with no input signals.
It displays the same channels for SXGA output, VIDEO output and the video transmission over a LAN interface.
There may be an image distortion (1frame:1/60sec.) at switching channels.

4-5. Displaying Split Screens

To display split screen, select and press a **SPLIT** button to display.

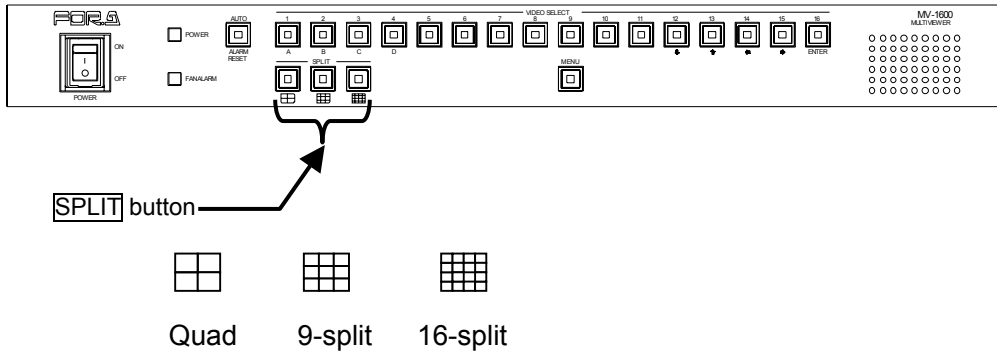

IMPORTANT

It displays the same channels for SXGA output, VIDEO output and the video transmission over a LAN interface, when the display is in the quad or 16-split screen mode. However, when 9-split screen mode is selected, it displays SXGA output in 9-split screen, but it displays VIDEO output and the video transmission over a LAN interface in 16-split screen.

◆ Correlation table of display screens

The table below shows the actual display screen in SXGA output, VIDEO output and the video transmission over a LAN interface for each display screen setting.

	SXGA output	VIDEO output	Video transmission over a LAN interface
Full screen setting	Full screen	Full screen	Full screen
Quad screen setting	Quad screen	Quad screen	Quad screen
9-split screen setting	9-split screen	16-split screen	16-split screen
16-split screen setting	16-split screen	16-split screen	16-split screen

◆ Split screen displays

Each split screen is displayed as below.

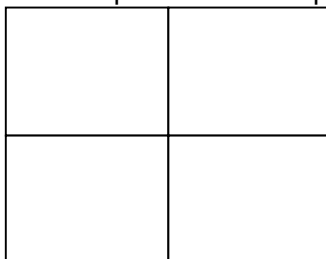

Quad screen

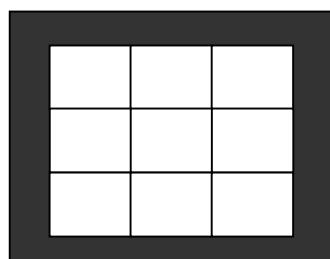

9-split screen
* Only in SXGA output

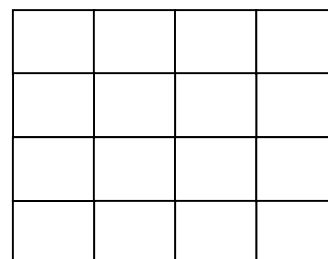

16-split screen

4-6. Selecting Split Screen Pages

In the MV-1600, the quad screen has four pages (A to D) and 9-split screen has two pages (A and B). The each page is allocated a set of different channels. The followings are the procedure to switch pages of each split screen.

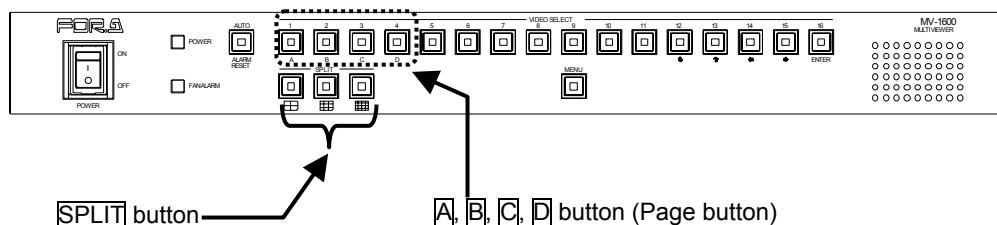

1. Press a **SPLIT** button for the split screen to display to enter split mode. In the split mode, the selected **SPLIT** button and the displayed page light up and the available pages flash for about 5 seconds.
2. Select and press a page button to display. The split mode is released, and the selected page stops flashing and lights up.
To switch the displayed page also need to press **SPLIT** button to enter split mode before pressing the page button to display.

◆ Channel assignment for each quad screen page (A to D)

1ch	2ch	5ch	6ch	9ch	10ch	13ch	14ch
3ch	4ch	7ch	8ch	11ch	12ch	15ch	16ch
A		B		C		D	

◆ Channel assignment for each 9-split screen page(A and B) *Only in SXGA output

1ch	2ch	3ch	10ch	11ch	12ch
4ch	5ch	6ch	13ch	14ch	15ch
7ch	8ch	9ch	16ch	1ch	2ch
A			B		

IMPORTANT

The page switching is not available for 16-split screen display.

In quad and 16-split screen, the same channels are displayed in SXGA output, VIDEO output and the video transmission over a LAN interface. However, when 9-split screen is selected, 9-split screen is displayed in SXGA output, but 16-split screen is displayed in VIDEO output and the video transmission over a LAN interface.

The channel assignments for pages cannot be changed.

There may be a distortion (1frame:1/60sec.) when switching channels.

4-7. Auto Sequencing Mode

The displayed channel in full screen display or page in split screen display can be changed automatically.

NOTE

The display interval can be set in the menu. See section 5-2-1. "Auto Sequencing Interval Settings" for details.

4-7-1. Full Screen Auto Sequencing

1. Press VIDEO SELECT **1** to **16** button to display a full screen.
2. Press **AUTO** button. The button lights up and it starts to switch channels automatically and sequentially.
3. Press VIDEO SELECT **1** to **16** button or any one of the **SPLIT** button to stop auto sequencing.

IMPORTANT

Channels without video signals and channels for which the auto sequencing intervals are set to '0' are automatically skipped.

There may be a distortion (1frame:1/60sec.) when switching channels.

4-7-2. Quad and 9-split Screen Auto Sequencing

1. Press the desired **SPLIT** button to display the split screen for auto sequencing.
2. Press the **AUTO** button. The button lights up and it starts to switch split pages automatically and sequentially.

IMPORTANT

Channels that meet any of the following conditions are automatically skipped.

- Channels with no video signal
- Channels for which the auto sequencing intervals are set to '0'. (See each channel settings in section 5-2-1. "Auto Sequencing Interval Settings".)

The auto sequencing interval can be set at SPLIT in AUTO SEQUENCING menu as described in section 5-2-1. "Auto Sequencing Interval Settings".

There may be a distortion (1frame:1/60sec.) when switching split pages.

In the example of the split screen auto sequencing below, the page D is not displayed:

e.g. Split configuration: quad

CH13, CH14 : No signal

CH15, CH16 Auto sequencing interval is set to '0' for each channel

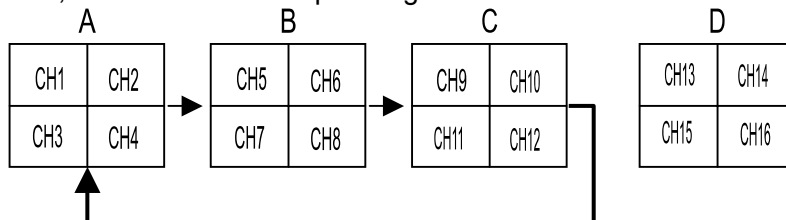

(IMPORTANT)

If auto sequencing is set for 9-split screen display, the display on VIDEO output and the video transmission over a LAN interface are in 16-split screen mode.

4-8. External Alarm and Video Loss Display

When an external alarm is received or video loss is detected, the unit can be automatically switched to the following two alarm displays (alarm display modes). The alarm display mode can be selected in the menu screen. For details on setting, see section 5-3. "ALARM/VIDEO LOSS".

4-8-1. Full Screen Setting

When an external alarm is received or video loss is detected, the corresponding channel is displayed in full screen. If more than one channel is affected, each channel is displayed sequentially for one second. Regular display operation is restored after all external alarms and video loss signals are cleared.

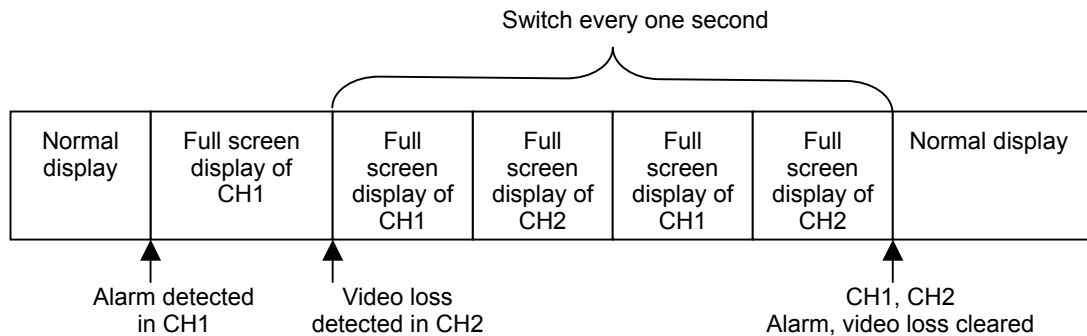

IMPORTANT

If ALARM is set to OFF in the menu, no alarm screen is shown when an alarm is detected. For details, see section 5-3. "ALARM/VIDEO LOSS".

If LOSS is set to OFF in the menu, no alarm screen is shown when a video loss is detected. For details, see section 5-3. "ALARM/VIDEO LOSS".

If an alarm is input while displaying the menu screen, the alarm input is not detected. If there is still an alarm input when returning to regular operation after exiting the menu screen, the alarm input is detected.

If the input video is cut off while displaying the menu screen, video loss is not detected. If the input video is not yet restored when returning to regular operation after exiting the menu screen, the video loss is detected.

There may be a distortion (1frame:1/60sec.) when switching channels.

◆ **SXGA Output Screen**

A tally frame and "A" are displayed for the channel that receives an alarm input.
a tally frame is displayed on the black screen for the channel that is affected by video loss.

<Alarm display>



<Video loss display>



IMPORTANT

If TALLY is set to OFF in the menu, the tally frame is not displayed. If MARK is set to OFF in the menu, "A" or "L" is not displayed. See section 5-5. "DISPLAY (Screen Display Settings)" for details.

◆ **VIDEO Output Screen and Video transmission over a LAN Interface**

"A" is displayed for the channel that receives an alarm input.
"L" is displayed on the black screen for the channel that is affected by video loss.

<Alarm display>



<Video loss display>

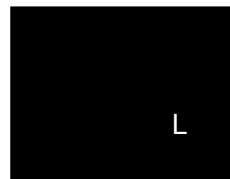

IMPORTANT

If MARK is set to OFF in the menu, "A" or "L" is not displayed. See section 5-5. "DISPLAY (Screen Display Settings)" for details.

4-8-2. Split Screen Setting

When an external alarm is received or video loss is detected, all channels are displayed in a 16-split screen. Regular display operation is restored after all external alarms and video loss signals are cleared.

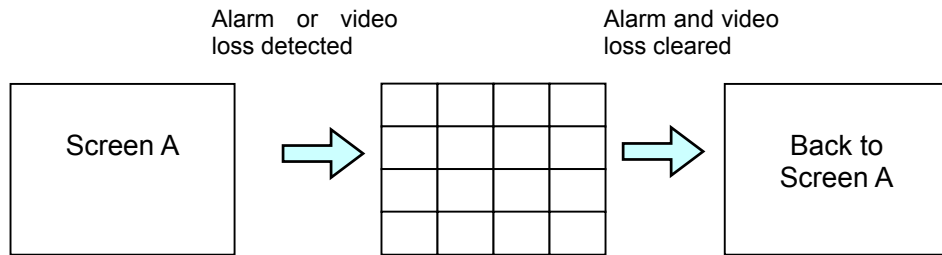

IMPORTANT

If ALARM is set to OFF in the menu, no alarm screen is shown when an alarm is detected. For details, see section 5-3. "ALARM/VIDEO LOSS".

If LOSS is set to OFF in the menu, no alarm screen is shown when a video loss is detected. For details, see section 5-3. "ALARM/VIDEO LOSS".

If an alarm is input while displaying the menu screen, the alarm input is not detected. If there is still an alarm input when returning to regular operation after exiting the menu screen, the alarm input is detected.

If the input video is cut off while displaying the menu screen, video loss is not detected. If the input video is not yet restored when returning to regular operation after exiting the menu screen, the video loss is detected.

◆ SXGA Output Screen

A tally frame and "A" are displayed for the channel that receives an alarm input. a tally frame and "L" are displayed on the black screen for the channel that is affected by video loss.

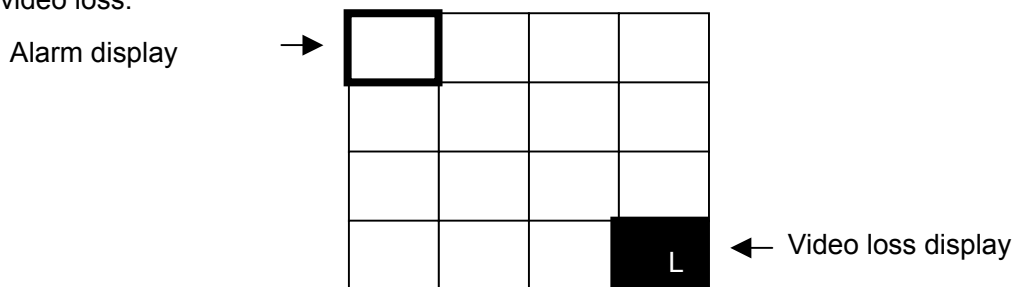

IMPORTANT

If TALLY is set to OFF in the menu, the tally frame is not displayed. If MARK is set to OFF in the menu, "A" or "L" is not displayed. See section 5-5. "DISPLAY (Screen Display Settings)" for details.

◆ **VIDEO Output Screen, Video transmission over a LAN Interface**

"A" is displayed for the channel that receives an alarm input.

"L" is displayed on the black screen for the channel that is affected by video loss.

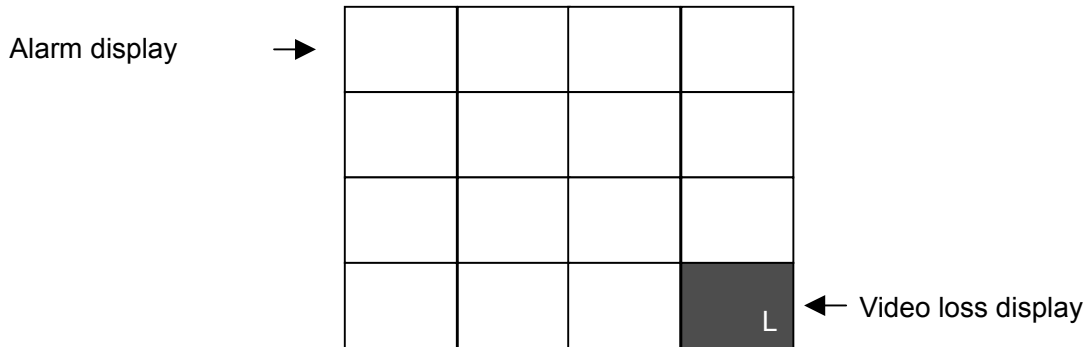

IMPORTANT

If MARK is set to OFF in the menu, "A" or "L" is not displayed. See section 5-5. "DISPLAY (Screen Display Settings)" for details.

4-8-3. Clearing Alarm or Video Loss Alarm Status

◆ **Clearing External Alarm Status**

You can clear alarms from external alarm systems by pressing the **ALARM RESET** button, when the external alarm input is set to "TRIG". (See section 5-3. "ALARM/VIDEO LOSS".) However, resetting the alarm with the **ALARM RESET** button is unavailable when the external alarm input is set to "LEVEL".

◆ **Clearing Video Loss Alarm Status**

You can clear alarms from video loss detection by pressing the **ALARM RESET** button at any time.

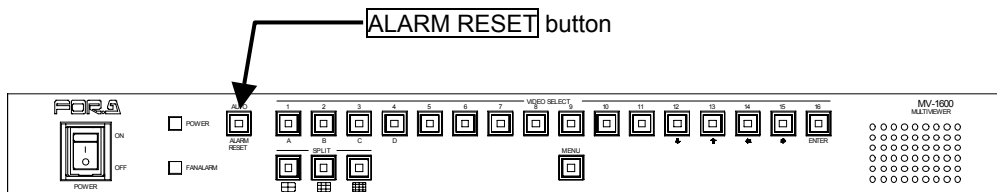

IMPORTANT

These clearing alarm or video loss alarm status procedures reset the alarm status or the video loss alarm status for SXGA output, VIDEO output and video transmission over a LAN interface.

5. Menu Operations

You can access submenus from the main menu to complete various settings.

5-1. Main Menu Display

Press and hold the **MENU** button for at least two seconds to display the main menu.

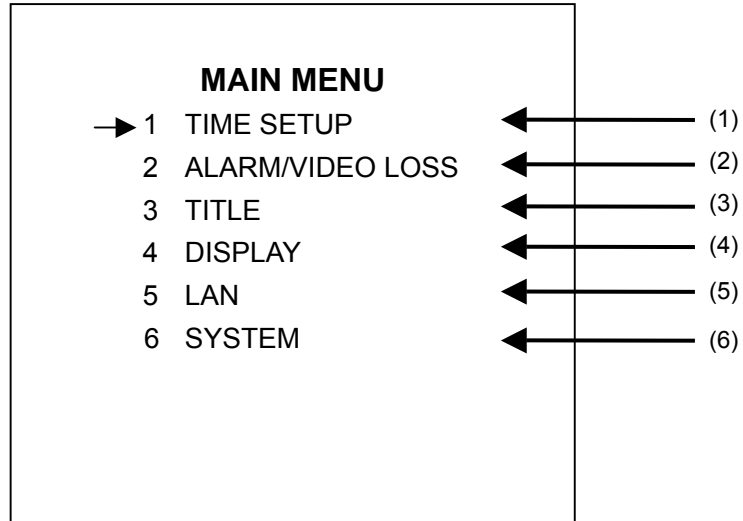

<Main Menu Screen>

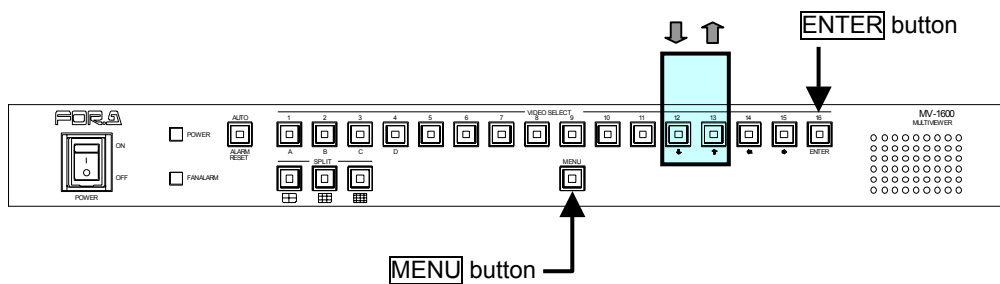

◆ **Operating Procedure**

Button	Action
↓	Moves the cursor down.
↑	Moves the cursor up.
ENTER	Accesses the submenu of the item selected.
MENU	Exits the menu.

◆ **Setting Items**

Item	Setting Description	Reference
(1) TIME SETUP	Auto sequencing time settings	5-2
	Split-screen automatic recovery time settings	
	Alarm reset time settings	
	Video loss reset time settings	
(2) ALARM/VIDEO LOSS	Alarm input mode settings	5-3
	Alarm display mode settings	
	Alarm operation ON/OFF	
	Video loss alarm operation ON/OFF	
(3) TITLE	Title settings for channels (SXGA, VIDEO output)	5-4
(4) DISPLAY	Title display On/Off settings for SXGA output / video transmission over a LAN	5-5
	"A", "L" display On/Off settings for SXGA / video transmission over a LAN	
	Tally display On/Off settings for SXGA output	
	Border display settings for SXGA output	
	Title display On/Off and position setting for VIDEO output	
	"A", "L" display On/Off settings for VIDEO output	
	Border display settings for VIDEO output	
(5) LAN	IP address settings	5-6
	Subnet mask length settings	
	Multicast address settings	
	Multicast port settings	
	Gateway settings	
(6) SYSTEM	Switch lock settings	5-7
	Function settings	
	REMOTE/ALARM interface settings	
	Network mode setting	
	ID setting	
	Password setting	

5-2. TIME SETUP (Time Settings)

On the main menu, move the cursor to [TIME SETUP], and then press the **ENTER** button. The TIME SETUP screen is displayed as shown below.

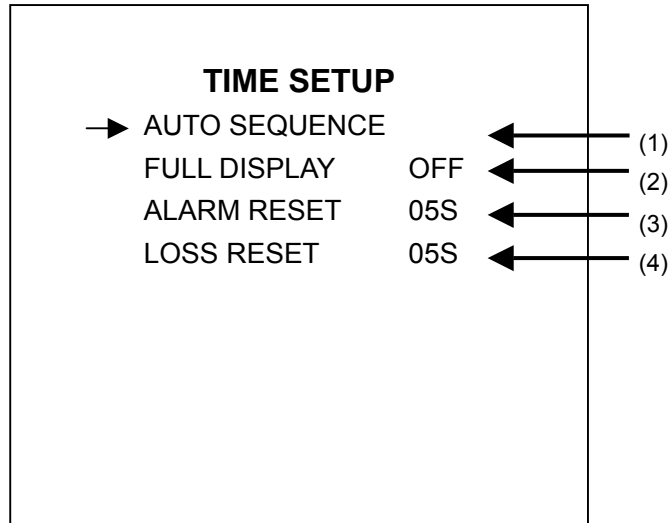

<TIME SETUP screen>

* The menu example above shows the factory set default values.

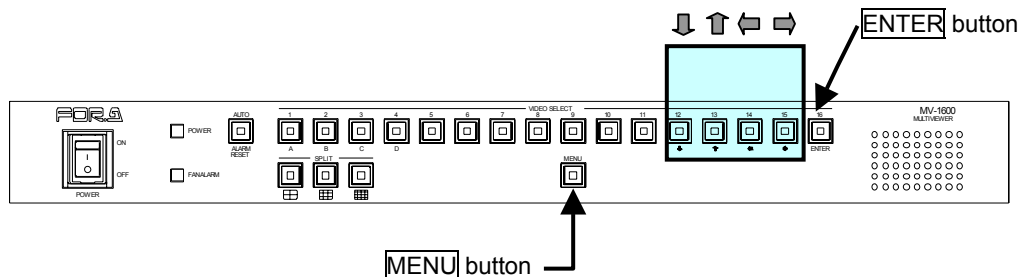

◆ Operation procedure

Button	Action
↓	Moves the cursor down.
↑	Moves the cursor up.
←	Changes the setting item value. (Reverse)
→	Changes the setting item value. (Forward)
MENU	Returns to the main menu

◆ Setting Items

Item	Setting Description	Reference
(1) AUTO SEQUENCE	Auto sequencing interval setting	5-2-1
(2) FULL DISPLAY	Time setting for automatic screen switching from full screen to split screen. (Settings are adjustable from 1 to 60 seconds. When set to OFF, automatic recovery is not performed. The factory default setting is Off.)	-
(3) ALARM RESET	Automatic alarm reset time setting when ALARM MODE is set to TRIG. (Settings are adjustable from 1 to 60 seconds. The factory default setting is 5 sec.)	-
(4) LOSS RESET	Automatic video loss reset time setting. (Settings are adjustable from 1 to 60 seconds. The factory default setting is 5 sec.)	-

5-2-1. Auto Sequencing Interval Settings

On the TIME SETUP screen, move the cursor to [AUTO SEQUENCE], and then press the **ENTER** button. The AUTO SEQUENCE screen is displayed as shown below. Auto sequencing interval for full screen display or split screen display can be set in this screen.

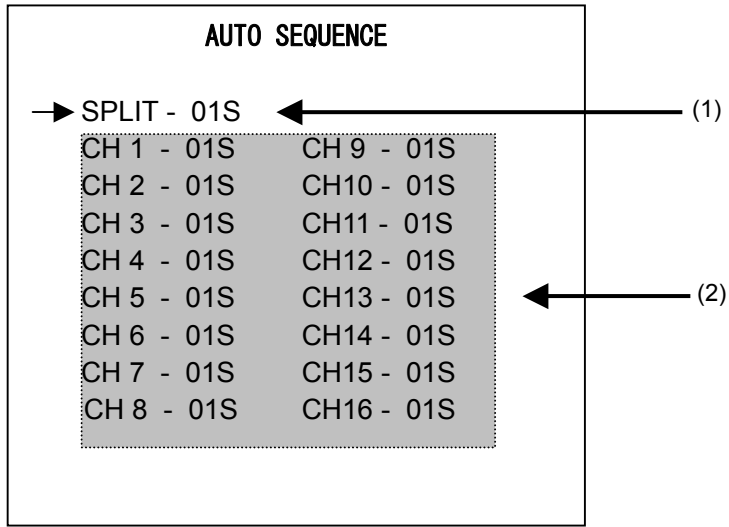

<AUTO SEQUENCE screen>

* The menu example above shows the factory set default values.

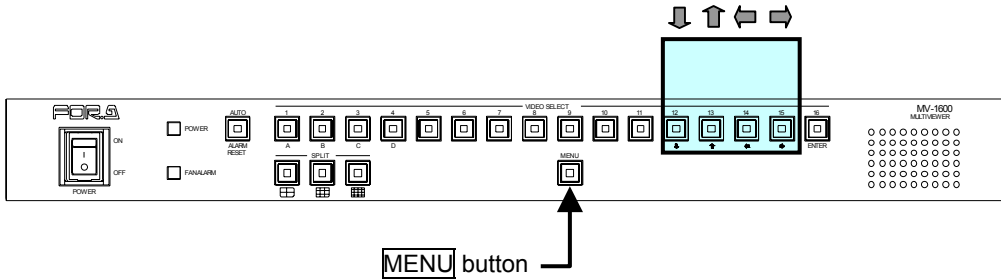

◆ Operation Procedure

Button	Action
	Moves the cursor into the next position.
	Moves the cursor in the opposite direction.
	Changes the setting item value.
MENU	Returns to the TIME SETUP menu.

◆ Setting Items

Item	Setting Description
(1) SPLIT	Auto sequencing interval setting of split screen display. (Settings are adjustable from one to 30 seconds.)
(2) Intervals for CH1 to CH16	Auto sequencing intervals for each channel during full screen display. (Settings are adjustable from 0 to 30 seconds.) Channels that are set to '0' seconds are automatically skipped.

NOTE

If there are split pages that you want to automatically skip, in item (2), set all channels displayed on that split page to '0' seconds so the split page can be skipped.

5-3. ALARM/VIDEO LOSS (Alarm and Video Loss Settings)

On the main menu, move the cursor to [ALARM/VIDEO LOSS], and then press the **ENTER** button. The ALARM/VIDEO LOSS screen is displayed as shown below. Use this screen to make settings for the alarm and video loss operation.

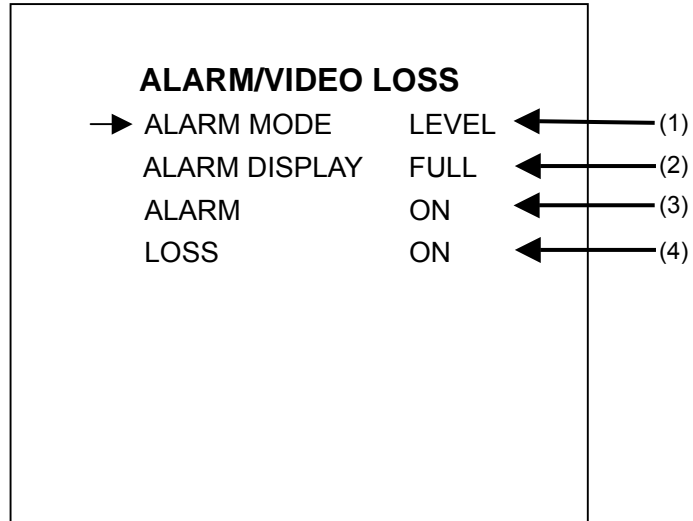

<ALARM/VIDEO LOSS screen>

* The menu example above shows the factory set default values.

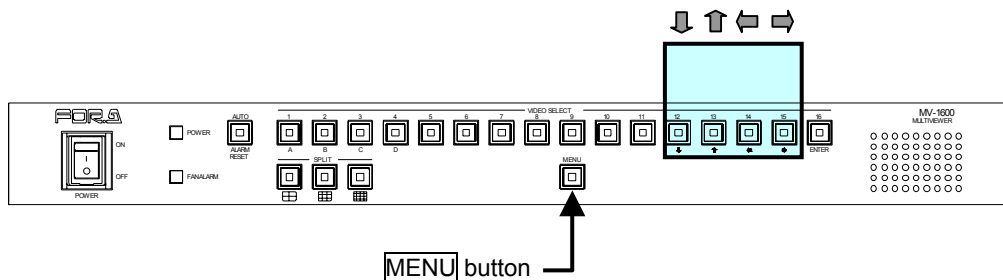

◆ Operation Procedure

Button	Action
	Moves the cursor down.
	Moves the cursor up.
	Changes the setting item value. (Reverse)
	Changes the setting item value. (Forward)
MENU	Returns to the main menu.

◆ **Setting Items**

Item	Setting Description
(1) ALARM MODE	<p>Selects alarm input modes from TRIG and LEVEL.</p> <p>TRIG: The alarm state is activated when the alarm input signal changes from high to low. The alarm is reset in the time that was set in ALARM RESET.</p> <p>LEVEL: The alarm state is activated while the alarm input signal is low.</p> <p>(The factory default setting is LEVEL.)</p>
(2) ALARM DISPLAY	<p>Selects the alarm display mode for an external alarm or video loss from FULL and SPLIT screen.</p> <p>FULL: The channel where the alarm was detected is displayed in full screen.</p> <p>SPLIT: When an alarm is detected, all channels are displayed in 16-split screen.</p> <p>(The factory default setting is FULL.)</p> <p>For details of operation in alarm display mode, see section 4-8. "External Alarm and Video Loss Display".</p>
(3) ALARM	<p>Enables (ON) or disables (OFF) alarm display operation at an external alarm detection.</p> <p>(The factory default setting is ON.)</p>
(4) LOSS	<p>Enables (ON) or disables (OFF) alarm display operation at a video loss detection.</p> <p>(The factory default setting is ON.)</p>

5-4. TITLE (Camera Title Settings)

On the main menu, move the cursor to [TITLE], and then press the **ENTER** button. The TITLE screen is displayed as shown below.

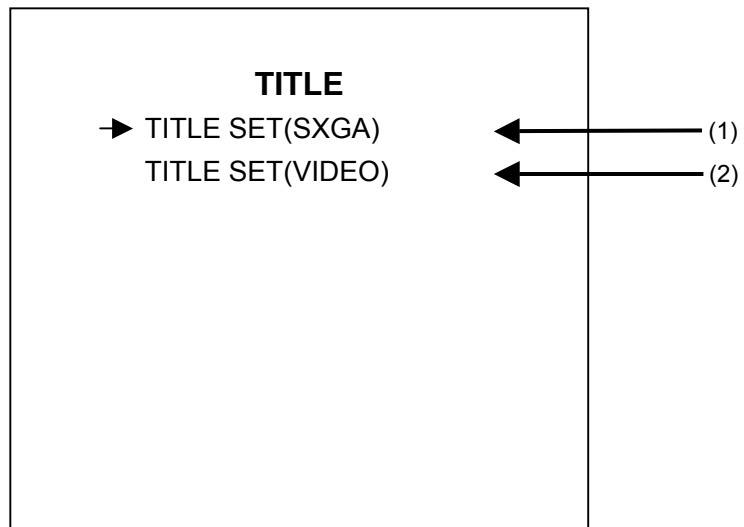

<TITLE screen>

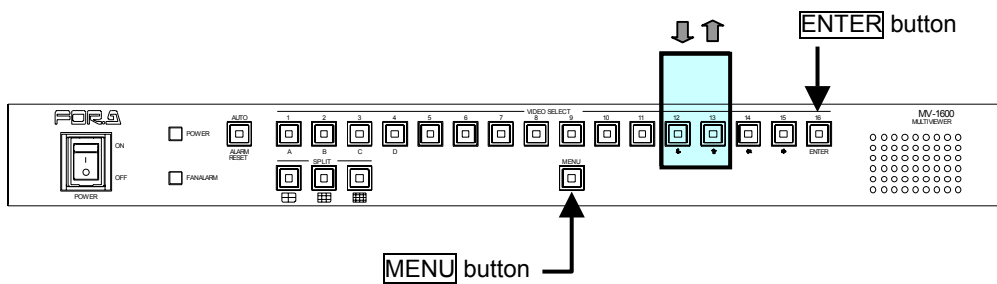

◆ Operation Procedure

Button	Action
↓	Moves the cursor down.
↑	Moves the cursor up.
ENTER	Accesses the submenu of the item selected.
MENU	Returns to the main menu.

◆ Setting Items

Item	Setting Description	Reference
(1) TITLE SET (SXGA)	Camera title settings for SXGA output	5-4-1
(2) TITLE SET (VIDEO)	Camera title settings for VIDEO output	5-4-1

5-4-1. TITLE SET (SXGA · VIDEO)

On the TITLE menu, move the cursor to [TITLE SET(SXGA)] or [TITLE SET(VIDEO)], and then press the **ENTER** button. The TITLE screen is displayed as shown below.

On this screen, titles of up to 8 characters long for SXGA output and video transmission over a LAN, and up to 6 characters long for VIDEO output can be set and displayed for each camera input.

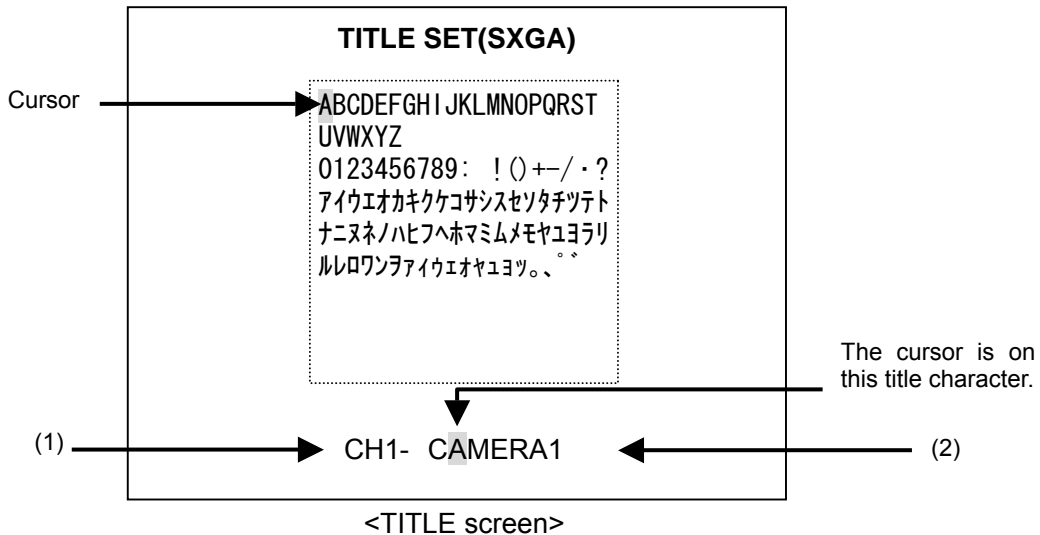

* The factory default is set to "CAMERA 1" to "CAMERA 16" for SXGA output and video transmission over a LAN interface, and "CAM 1" to "CAM 16" for VIDEO output.

* The menu example above shows the display of TITLE SET (SXGA).

*The blank character (space) is located between ":" and "!".

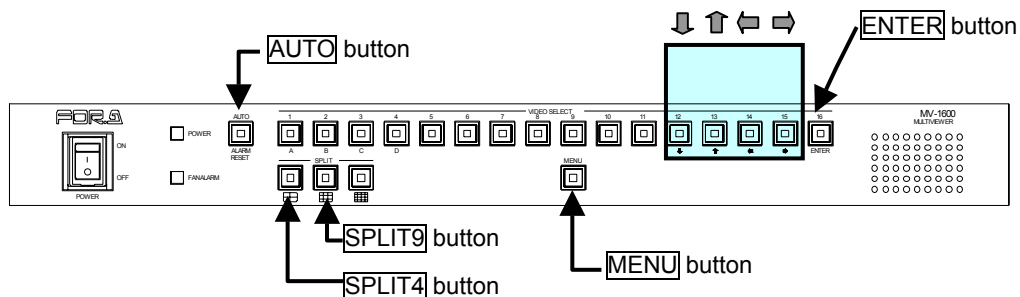

◆ Operation Procedure

Button	Action
↑	Moves the cursor up.
↓	Moves the cursor down.
←	Moves the cursor left.
→	Moves the cursor right.
ENTER	Sets the character selected by the cursor to the cursor pointing position.
SPLIT 4	Moves the cursor left on the title line to enter a character.
SPLIT 9	Moves the cursor right on the title line to enter a character.
AUTO	Selects the channel to set title on.
MENU	Returns to the TITLE menu.

◆ **Setting Items**

Button	Setting Description
(1) CH 1 to 16	Selects a channel to set the title for by using AUTO button.
(2) Camera Title	Sets the title by using ↓ , ↑ , ← , → buttons and ENTER button. Selecting the position on the title line to set the selected character is made by SPLIT4 and SPLIT9 buttons.

5-5. DISPLAY (Screen Display Settings)

On the main menu, move the cursor to [DISPLAY], and then press the **ENTER** button. The DISPLAY screen is displayed as shown below. Use this screen to set each screen display on or off.

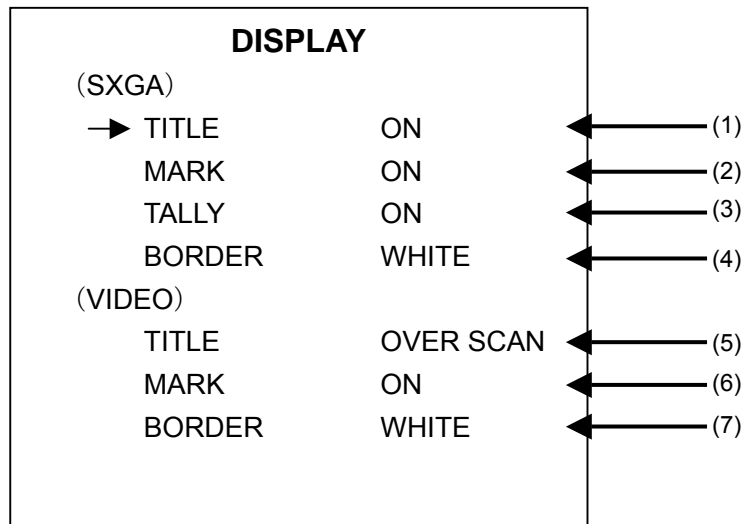

<DISPLAY screen>

* The menu example above shows the factory set default values.

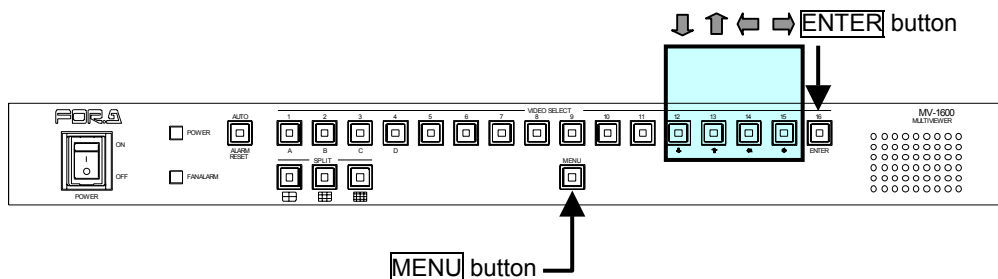

◆ Operation Procedure

Button	Action
	Moves the cursor down.
	Moves the cursor up.
	Changes the setting item value. (Reverse)
	Changes the setting item value. (Forward)
MENU	Returns to the main menu.

◆ **Setting Items**

Item	Setting Description
(1) TITLE (SXGA)	Camera title display ON/OFF setting for SXGA output and video transmission over a LAN interface.
(2) MARK (SXGA)	"A" and "L" display ON/OFF setting for alarm and video loss in SXGA output and video transmission over a LAN interface.
(3) TALLY (SXGA)	Tally frame display ON/OFF setting for alarm and video loss in SXGA output
(4) BORDER (SXGA)	Selects border display from white, black or off for SXGA output.
(5) TITLE (VIDEO)	Selects camera title display mode for VIDEO output. UNDER SCAN: suitable for the monitor which has the under scan function. OVER SCAN: suitable for the standard monitor. OFF : no title display * This setting is shared by VIDEO OUT 1 and VIDEO OUT 2.
(6) MARK (VIDEO)	"A" and "L" display ON/OFF setting for alarm and video loss channel in VIDEO output * This setting is shared by VIDEO OUT 1 and VIDEO OUT 2.
(7) BORDER (VIDEO)	Selects border display from white, black or off for VIDEO output. * This setting is shared by VIDEO OUT 1 and VIDEO OUT 2.

5-6. LAN (LAN Settings)

On the main menu, move the cursor to [LAN], and then press the **ENTER** button. The LAN screen is displayed as shown below.

Use this screen to make various settings for LAN interface.

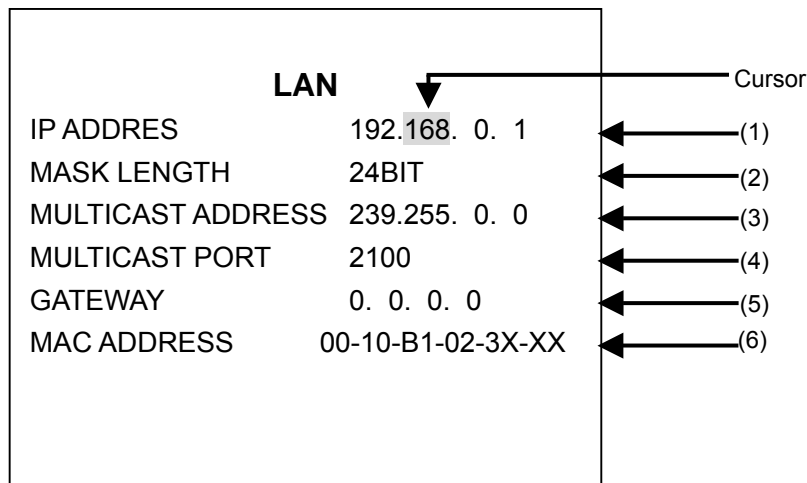

<LAN screen >

* The menu example above shows the factory set default values.

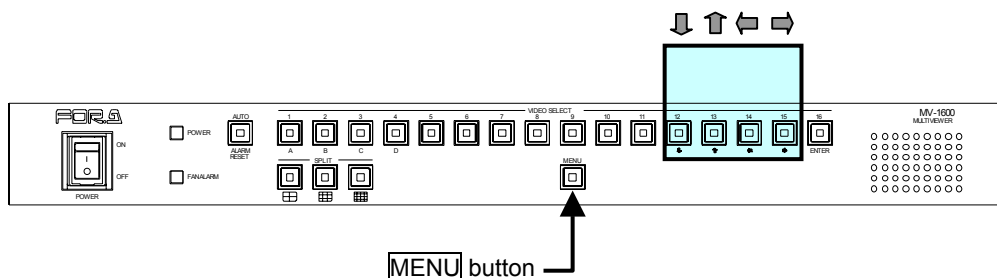

◆ Operation Procedure

Button	Action
	Moves the cursor to the next item.
	Moves the cursor back to the previous item.
	Changes the setting item value. (Reverse)
	Changes the setting item value. (Forward)
MENU	Returns to the main menu.

IMPORTANT

If the **MENU** button is pressed to enter invalid value, an error message will be displayed. Clear the error and correct the value using buttons.

◆ **Operation Items**

Item	Operation Description
(1) IP ADDRESS	Set an IP address for the MV-1600. Be sure to make the setting when using over a LAN interface. Please consult with your system administrator if using in your existing network. Set between "0.0.0.0" - "255.255.255.255" However, it cannot be set to "0.0.0.0" or "1.0.0.0".
(2) MASK LENGTH	Set a subnet mask for the MV-1600. Set between "0" - "31"
(3) MULTICAST ADDRESS	Set a Multicast address to operate in the multicast mode. The setting range is 224.0.0.0 to 239.255.255.255 except from 224.0.0.0 to 224.0.0.255. *This setting is not necessary if operating in the unicast mode.
(4) MULTICAST PORT	Set a Multicast port to operate in the multicast mode. The setting range is 1024 to 65535. *This setting is not necessary if operating in the unicast mode.
(5) GATEWAY	If your using network does not have a gateway, this setting is not required. Set between "0.0.0.0" - "255.255.255.255"
(6) MAC ADDRESS	Display the MAC address value that is set for the device. This setting cannot be changed.

IMPORTANT

The LAN interface settings except MULTICAST ADDRESS and MULTICAST PORT are applied when the power to the MV-1600 is turned on. If those settings are changed, be sure to turn off the MV-1600 and then turn it on again to apply the settings.

5-7. SYSTEM (System Settings)

On the main menu, move the cursor to [SYSTEM], and then press the **ENTER** button. The SYSTEM screen is displayed as shown below.

Use this SYSTEM screen to select SXGA output or video transmission over a LAN interface.

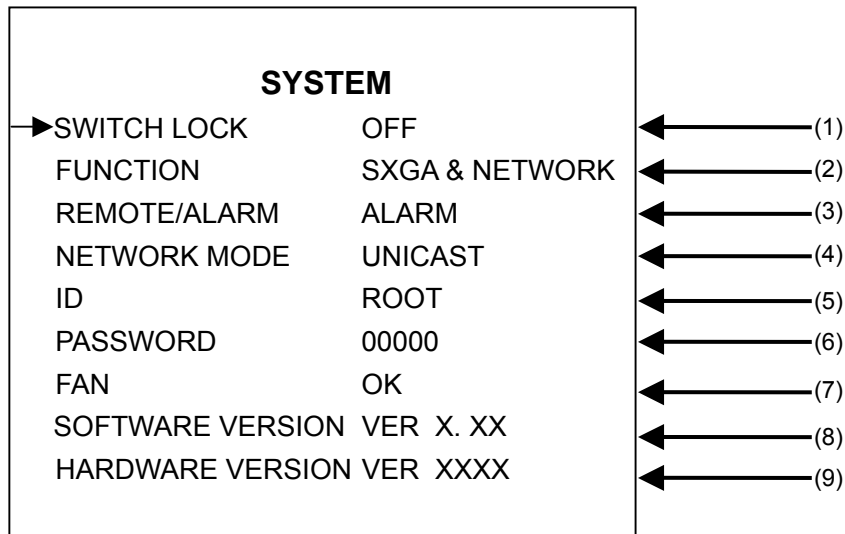

<SYSTEM screen >

* The menu example above shows the factory set default values.

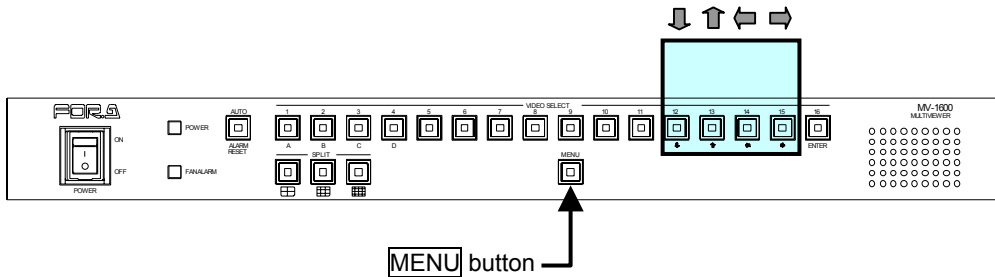

◆ Operation Procedure

Button	Action
↓	Moves the cursor down.
↑	Moves the cursor up.
←	Changes the setting item value. (except ID and Password)
→	Changes the setting item value. (except ID and Password)
ENTER	Opens the submenu to which the cursor is positioned. (ID and Password only)
MENU	Returns to the main menu.

◆ Operating Procedure (Parameter settings)

Button	Action
↓	Moves the cursor right.
↑	Moves the cursor left.
←	Changes the setting item value. (Reverse)
→	Changes the setting item value. (Forward)
ENTER	Returns to select setting item.
MENU	Returns to select setting item.

◆ **Setting Items**

Item	Setting Description	
(1) SWITCH LOCK	Disable or enable buttons on the front panel OFF: Activates buttons. ON: Deactivates buttons except the MENU button. If any front panel button except MENU button is pressed while buttons are deactivated, the MENU button flashes to indicate that the Switch Lock is on.	
(2) FUNCTION	Operation mode setting	
	SXGA	The SXGA output is enabled. The video transfer is also enabled. However, due to the priority on the SXGA output, the frame rates (refresh interval) of video transfer over the LAN interface is reduced.
	NETWORK	The video transfer over the LAN interface is enabled.
	NETWORK+A	The video transfer over the LAN interface with alarm/video loss information is enabled.
	SXGA& NETWORK	Both the SXGA output and the video transfer over the LAN interface are enabled. However, the frame rates of both functions become lower than those of when using either one alone.
SXGA& NETWORK+A	Concurrent use of the SXGA output and the video transfer over the LAN interface with the alarm/video loss information is enabled.	
(3) REMOTE / ALARM	Sets the connector on the rear panel to REMOTE control or ALARM input. REMOTE: Enables the remote control of the MV-1600. ALARM: Enables to receive external alarm inputs. * CH1 to CH16 of REMOTE receive alarm signals.	
(4) NETWORK MODE	Network mode setting	
	UNICAST	Sets to the unicast mode.
	MULTICAST	Sets to the multicast mode.
(5) ID	Sets the ID for the connection with Web browser and the dedicated software. Set with up to 8 alphanumeric characters. If all 8 characters are set with the space character, the authentication is not performed.	
(6) PASSWORD	Sets Password for the connection with Web browser and the dedicated software. Set with 5-digit numbers.	
(7) FAN	Displays the fan status. OK: The fan is operating without problem. NG: An error has occurred in the fan.	
(8) SOFTWARE VERSION	Displays the internal software version,.	
(9) HARDWARE VERSION	Displays the internal hardware version.	

IMPORTANT

To stop transmitting video, set the frame rate to "0". See the appendix MV-1600 RS-232C/LAN Command, section 2-7, "Video Transmission Frame Rate Commands" for details.

The ID and PASSWORD settings are applied when the power to the MV-1600 is turned on. If the settings are changed, be sure to turn off the MV-1600 and then turn it on again to apply the settings.

6. REMOTE / ALARM Interface

6-1. Connector Pin Assignments

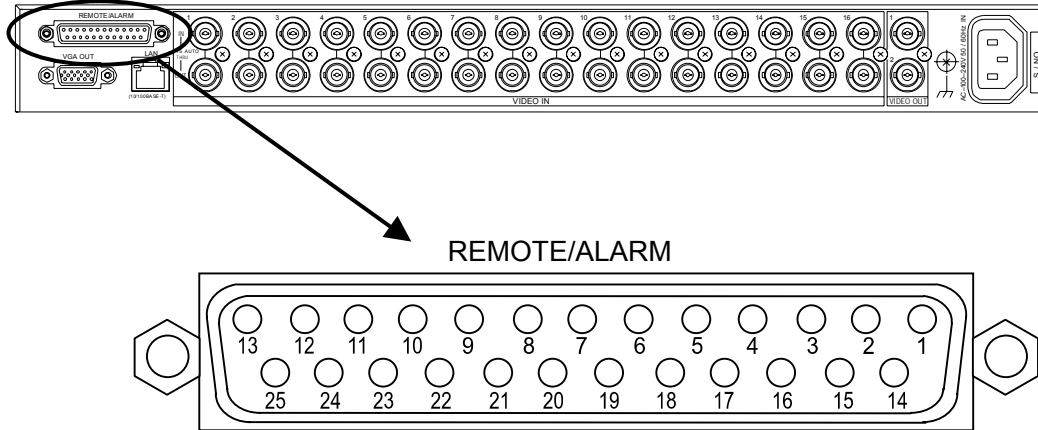

Compatible connector (male) DB-25PF-N(JAE)
 Cover: DB-C4-J11-S1(JAE)
 * Use inch type screws.

Connector Pin Assignments and Functions

Pin no.	Function	Pin no.	Function
1	+5V output (max. 200mADC)	14	CH12 REMOTE/ALARM
2	AUTO/RESET	15	CH13 REMOTE/ALARM
3	CH1 REMOTE / ALARM	16	CH14 REMOTE / ALARM
4	CH2 REMOTE / ALARM	17	CH15 REMOTE / ALARM
5	CH3 REMOTE / ALARM	18	CH16 REMOTE / ALARM
6	CH4 REMOTE / ALARM	19	SPLIT4
7	CH5 REMOTE / ALARM	20	SPLIT9
8	CH6 REMOTE / ALARM	21	SPLIT16
9	CH7 REMOTE / ALARM	22	RS-232C TxD
10	CH8 REMOTE / ALARM	23	RS-232C RxD
11	CH9 REMOTE / ALARM	24	FAN ALARM
12	CH10 REMOTE / ALARM	25	GND
13	CH11 REMOTE / ALARM	-	

IMPORTANT

Pins 2 and 19 to 24 for ALARM are assigned the same as REMOTE.

6-2. REMOTE Interface

◆ Pin Assignments

<Pin Array>

See section 6-1. "Connector Pin Assignments".

<Function>

REMOTE control

function	Action	Reference
AUTO / RESET	Sets auto sequencing or resets alarm or video loss alarm the same as the AUTO / ALARM RESET button on the front panel.	4-7-1. "Full Screen Auto Sequencing" 4-7-2. "Quad and 9-split Screen Auto Sequencing" 4-8-3. "Clearing Alarm or Video Loss Alarm Status"
CH 1 to 16	Selects a channel to display on full screen the same as the SELECT1 to 16 buttons on the front panel.	4-4. "Displaying Full Screen" 4-6. "Selecting Split Screen Pages"
SPLIT 4, 9, 16	Selects a split screen mode to display the same as the SPLIT4, 9 and 16 buttons on the front panel.	4-5. "Displaying Split Screens"

◆ **Circuit Example**

*The input signal pulse width should be 100ms or more. Also the input signal interval should be 100ms or more.

1)

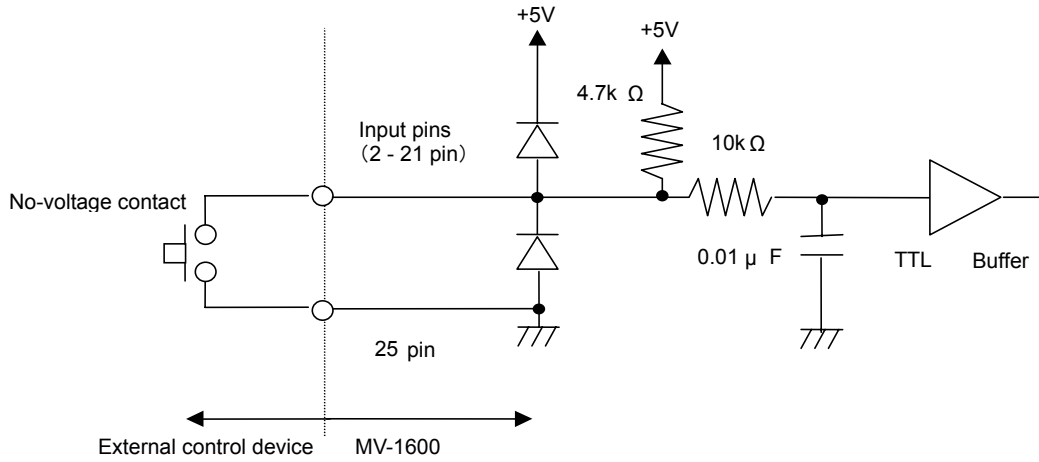

2)

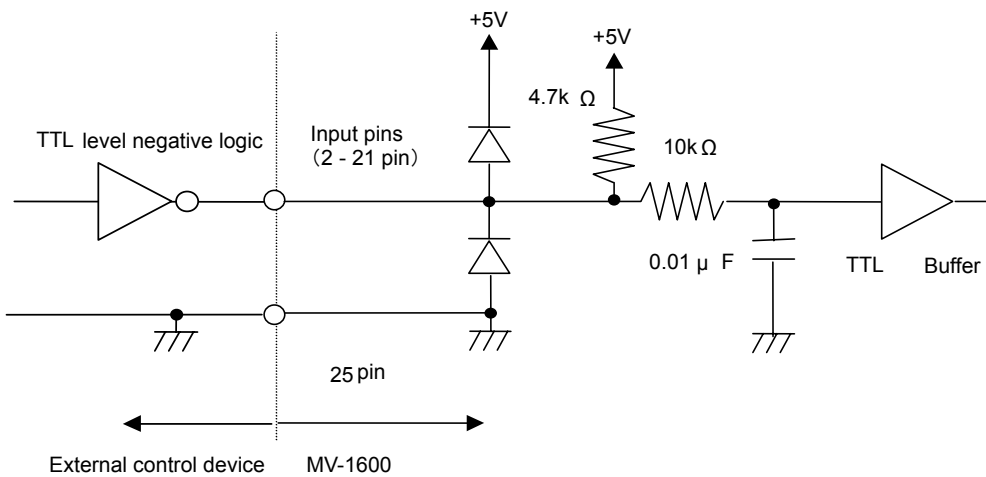

IMPORTANT

When ALARM is selected at REMOTE/ALARM setting in SYSTEM menu, remote control to CH1 to CH16 is not available. See section 5-7. "SYSTEM (System Settings)" for details.

6-3. ALARM Interface

◆ Pin Assignments

<Pin Array>

See section 6-1. "Connector Pin Assignments"

<Function>

See section 4-8. "External Alarm and Video Loss Display".

◆ Alarm Input Circuit Example

*The input signal pulse width should be 100ms or more. (when alarm mode is set to TRIG.)

NOTE

Circuit is the same as REMOTE interface. See section 6-2. "REMOTE".

IMPORTANT

When REMOTE is selected at REMOTE/ALARM setting in SYSTEM menu, external alarm input cannot be received. See section 5-7. "SYSTEM (System Settings)" for details.

6-4. FAN ALARM Output

◆ Pin Assignments

<Pin Array>

See section 6-1. "Connector Pin Assignments"

<Function>

The pin 24 outputs a fan alarm signal whenever the fan installed in MV-1600 is stopped.
The fan alarm output is low level.

◆ Alarm Output Circuit Example

Open Collector

74LS06(TTL) or equivalent

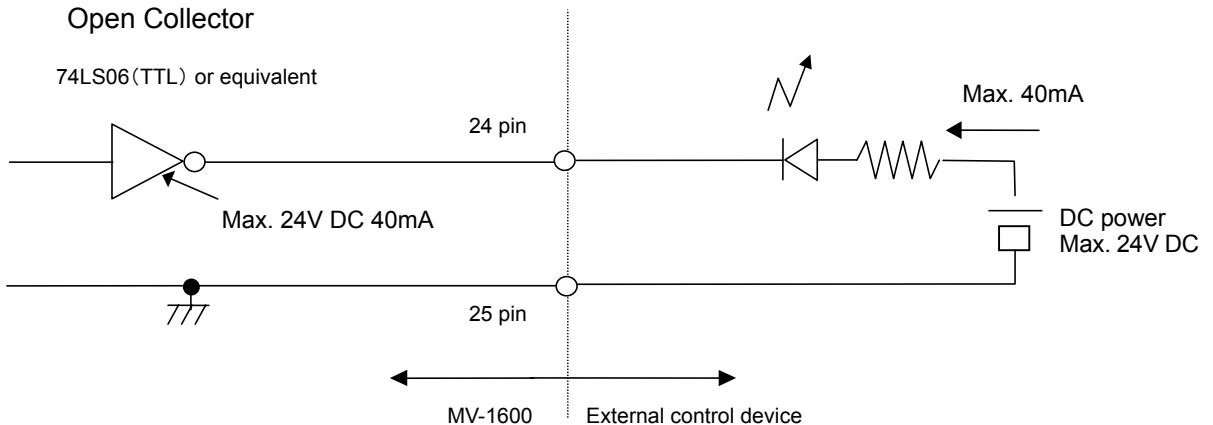

6-5. RS-232C Interface

The command formats are shared for the RS-232C interface and LAN interface. See appendix "RS-232C/LAN Command" for the protocol commands.

6-5-1. RS-232C Connector

RS-232C is assigned to the ALARM/REMOTE connector. See section 6-1. "Connector Pin Assignments" for the pin assignment.

6-5-2. Cable Connection Example

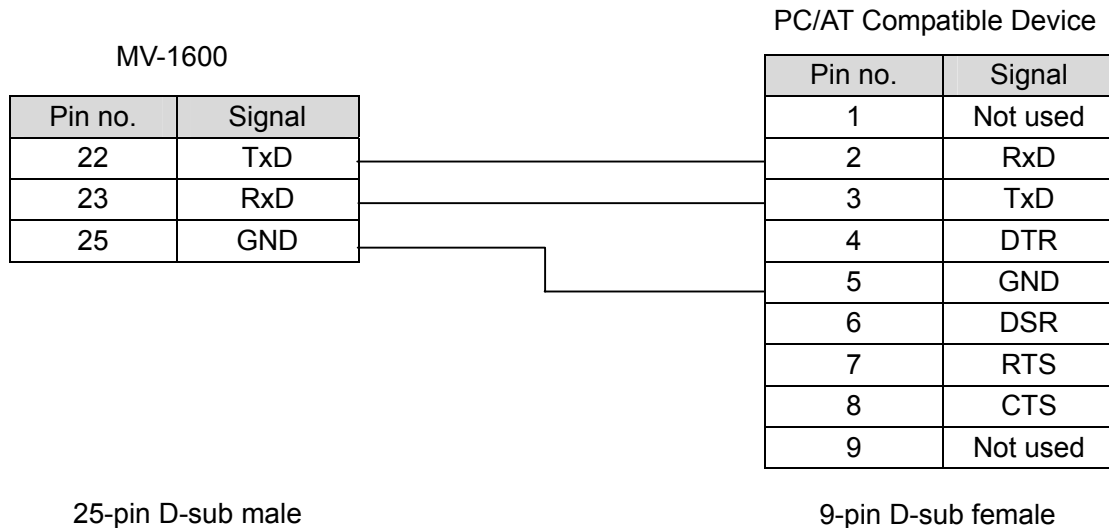

6-5-3. Communication Standard

<Serial Communication Standard>

Transmission mode	Asynchronous, Full-duplex
Bit rate	9600bps
Data length	8bit
Stop bit	1bit
Parity	None
Flow control	None

7. LAN Interface

The command formats are shared for the RS-232C interface and LAN interface. See appendix "RS-232C/LAN Command" for the protocol commands.

7-1. LAN Connector

<LAN Connector Pin Assignment>

Pin no.	Signal	Description
1	TxD+	Signal transmission line +
2	TxD-	Signal transmission line -
3	RxD+	Signal reception line +
4	-	Unassigned
5	-	Unassigned
6	RxD-	Signal reception line -
7	-	Unassigned
8	-	Unassigned

7-2. Ethernet Communication Standard

<Ethernet Communication Standard>

Bit rate	10Mbps/100Mbps, full/half-duplex auto switching
Access method	CSMA/CD (IEEE802.3 compliance)
Ethernet medium	10BASE-T/100BASE-TX
Connector	RJ-45
Required Cable	Category 5 cable, twisted pair cable (UTP or STP)

IMPORTANT

It takes a few minutes or more to restore the connection, if the connection is abruptly closed for some reason. In such a case, wait for a while or restart the main system before reconnecting.

8. Troubleshooting

If any of the following problems occur during operation of the MV-1600, before assuming a unit malfunction has occurred, follow the troubleshooting procedures below to see if the problem can be corrected.

IMPORTANT

If the problem is not corrected by performing the procedures below, turn the unit off and then on again. If this still does not correct the problem, contact your dealer.

Problem	Check	Action
Front panel FAN ALARM indicator is lit or flashing.	Check that no objects are blocking the fan vent on the side panel.	Remove any objects blocking the fan vent. If there are no objects in the way, the fan may need to be replaced. Contact your dealer for assistance.
No information is displayed on the screen.	Are all information display settings set to ON?	Check the display settings in the main menu. See section 5-5. "DISPLAY" for details.
Unable to operate front panel buttons.	Is the MENU button flashing?	Turn off the Switch lock. See section 5-7. "SYSTEM" for details.
I want to restore the default settings.		Hold down the AUTO button on the front panel while turning the unit on. All backup data will be initialized.

9. Specifications and Dimensions

9-1. Specifications

TV Standard	525/60 (NTSC) or 625/50 (PAL) (Auto detection)
Video Input	1.0V(p-p)(Color or B/W, 75Ω or loopthrough (automatic termination) BNC, 16 inputs (Accepts asynchronous)
Video Output	
VGA OUT	15 pin D-Sub 1 output Resolution: SXGA (1280 x 1024pixels) *Video:1280 x 960pixels Horizontal scanning frequency: 64.0kHz Vertical scanning frequency: 60.0Hz Video signal: 0.7V(p-p) ±0.1V 75Ω Reference signal: Separate HV sync (TTL positive logic pulse, level signal) Screen display: Select from Full, quad, 9-split or 16-split screen * Simultaneous use of SXGA output and the video transmission over a LAN functions drops the frame rate (refresh rate) to half of using SXGA output function alone.
VIDEO OUT 1, 2	1.0V(p-p)±0.1V 75Ω BNC 2 outputs Screen display: Select from Full, quad, 16-split screen
Interface	
Remote	ALARM/REMOTE connector 25-pin D-sub female TTL negative logic pulse or contact closure (more than 100ms width) Control: AUTO/RESET, selecting camera 1 to 16, selecting screen display SPLIT4, 9 or 16 * Not active when setting is made for ALARM.
Alarm input	ALARM/REMOTE connector 25-pin D-sub female TTL negative logic pulse level or contact closure, (more than 100ms width for the trigger signal), 16 inputs * Not active when setting is made for REMOTE.
RS-232C	ALARM/REMOTE connector 25-pin D-sub female Asynchronous, full-duplex, bit rate 9,600bps, data length 8bit, stop bit 1bit, parity none, 1 line Control: selecting Video output, menu settings
LAN	10BASE-T/100BASE-TX, RJ-45 (Category 5), 1 ea. Control: selecting Video output, menu settings Video output: maximum frame rate 60fps Compression method JPEG Screen display: Select from full, quad or 16-split screen Image size: select from SXGA (1280×960 pixels) or VGA (640×480 pixels) *Maximum frame rate may change depending on use environment. * Simultaneous use of SXGA output and the video transmission over a LAN functions drops the frame rate (refresh rate) lower than using the video transmission over a LAN function alone.

Character Display

Camera Title

SXGA output, video transmission over a LAN interface

8 characters/1 line max. (alphanumeric characters, symbols and Japanese kana available)

VIDEO output 1, 2

6 characters/1 line max. (alphanumeric characters, symbols and Japanese kana available)

Warnings

ALARM

Auto switching to alarm screen,

SXGA output: displays tally frame and "A"

VIDEO output and video transmission over a LAN: displays "A"

VIDEO LOSS

Auto switching to video loss screen,

SXGA output: displays tally frame and "L"

VIDEO output and video transmission over a LAN: displays "L"

Data Storage

Back up data for menu settings with EEPROM.

Power

100VAC to 240VAC $\pm 10\%$, 50Hz/60Hz

Consumption

28VA (27W) at 100VAC

Temperature

0°C - 40°C

Humidity

30% - 90% (no condensation)

Dimensions

424 (W) \times 44 (H) \times 350 (D)mm

Weight

4.5kg

Consumables

Cooling fan: P1385 (front) Replace every 5 years (at normal temperature)

Power unit: 100VAC: Replace every 2.1 years (at 40°C)

200VAC: Replace every 2.2 years (at 40°C)

9-2. External Dimensions

(All dimensions in mm)

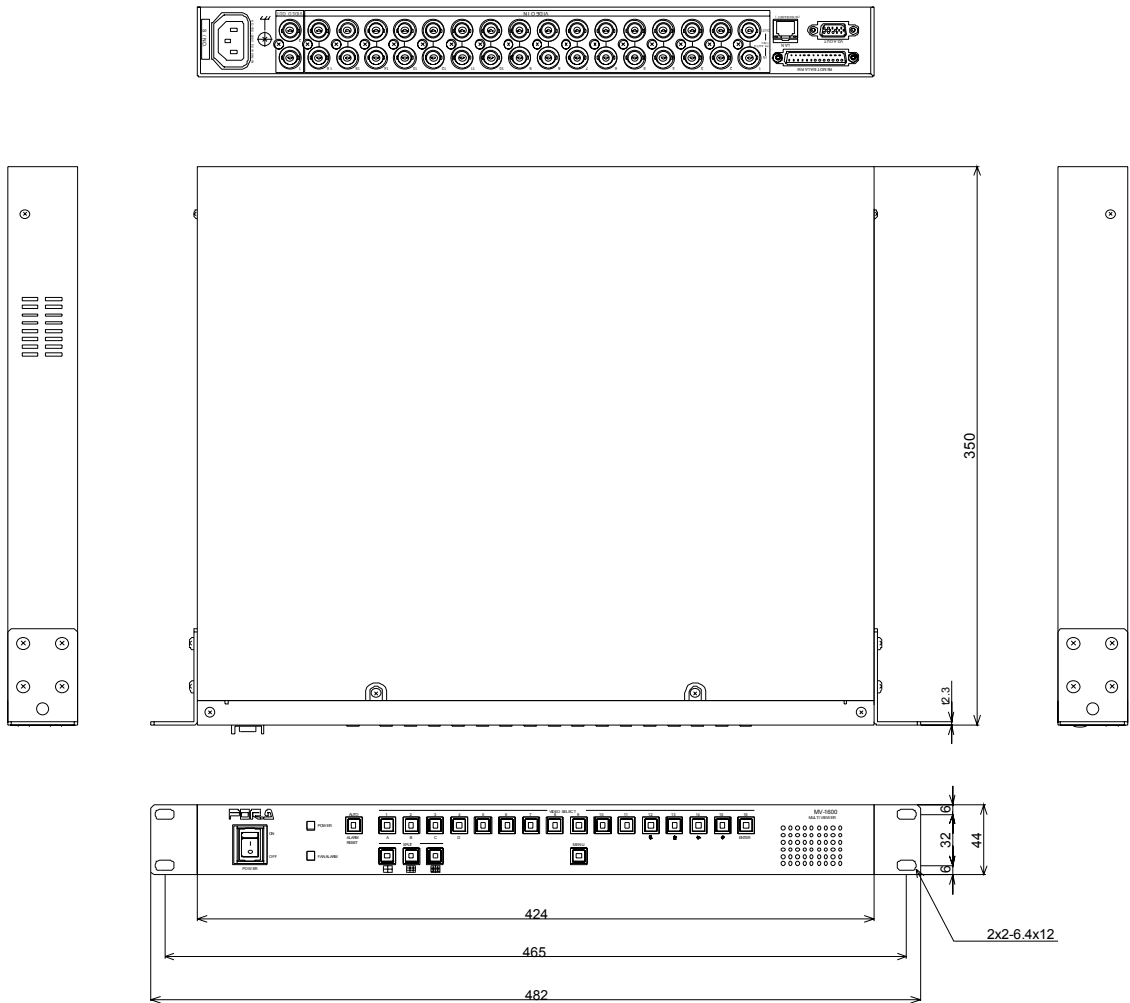

RS-232C/LAN COMMAND

MV-1600

Multi Viewer

Table of Contents

1. Communication Standards.....	1
1-1. RS-232C Interface Communication Standards	1
1-2. LAN Interface Communication Standard.....	1
1-3. Notes for the LAN Interface	2
1-4. Command Protocol Format.....	4
1-5. Response Message Format.....	5
1-6. Image Data Format for Video Transmission over a LAN Interface.....	6
2. Control Commands.....	8
2-1. Full Screen Display Command	8
2-2. Split Screen Display Command	8
2-3. Change Page Command	9
2-4. Auto Sequencing Start Command.....	9
2-5. Alarm Reset Command.....	9
2-6. Alarm Input Command	10
2-7. Video Transmission Frame Rate Commands.....	10
2-8. Video Transmission JPEG Compression Ratio Commands.....	11
2-9. Video Transmission Screen Size Command.....	11
2-10. Add Data in Image Data Format Command	11
3. Status Request Commands	12
3-1. Version Request Command.....	12
3-2. Video Format Request Command.....	12
3-3. Output Status Request Command	13
3-4. Alarm Data Request Command	14
3-5. Fan Alarm Status Request Command.....	15
3-6. Video Transmission Status Request Command.....	16
3-7. Data Addition in Image Data Format Setting Status Request Command	17
4. Menu Setting Control	18
4-1. Command Format.....	18
4-2. Menu Setting Commands	19
4-2-1. TIME SETUP Setting Command.....	19
4-2-2. AUTO SEQUENCE Setting Command	19
4-2-3. ALARM / VIDEO LOSS Setting Command	20
4-2-4. TITLE Setting command	20
4-2-5. DISPLAY Setting Command	22
4-2-6. SYSTEM Setting Command	23
4-2-7. MULTICAST Setting Command	24
4-3. Menu Setting Status Request Command.....	25
4-3-1. TIME SETUP Setting Status Request Command.....	25

4-3-2. AUTO SEQUENCE Setting Status Request Command.....	25
4-3-3. ALARM/VIDEO LOSS Setting Status Request Command.....	26
4-3-4. TITLE Setting Status Request Command.....	27
4-3-5. DISPLAY Setting Status Request Command.....	28
4-3-6. SYSTEM Setting Status Request Command.....	29
4-3-7. MULTICAST Setting Status Request Command	30

1. Communication Standards

1-1. RS-232C Interface Communication Standards

The communication standard for serial control over a RS-232C interface is shown below.

Bit rate	9,600bps
Data length	8 bit
Stop bit	1 bit
Parity	None
X parameter (flow control)	None

For the details of the RS-232C interface connector and cable, refer to section 6-5. "RS-232C Interface" in the MV-1600 Operation Manual

1-2. LAN Interface Communication Standard

The communication standard for serial controller over a LAN interface is shown below.

Item	Description
Compatible communication protocol	Data link layer: CSMA/CD Network layer: IP, ICMP, ARP, RARP Transport layer: TCP, UDP Application layer: socket
IP address	Set range: "0.0.0.0" to "255.255.255.255" (except "0.0.0.0" and "1.0.0.0") * Set from MENU screen of main unit. * The initial setting is "192.168.0.1".
Subnet mask (Mask length)	Set range: 0 - 31 * Set from MENU screen of main unit. * The initial setting is "24".
Multicast address	Set range: "224.0.0.0" to "239.255.255.255" (except "224.0.0.0" to "224.0.0.255") * Set from MENU screen of main unit, or by web browser or the LAN command. * The initial setting is "239.255.0.0".
Multicast port	Set range: 1024 - 65535 * Set from MENU screen of main unit, or by web browser or the LAN command. * The initial setting is "2100".
Gateway	Set range: "0.0.0.0" to "255.255.255.255" * Set from MENU screen of main unit. * "0.0.0.0" means that gateway is not set. * The initial setting is "0.0.0.0".
Port	2000: For receiving image data in video transmission over a LAN. 2001: For sending and receiving commands.
MAC address	Set at the factory (cannot change). * The contents can be seen on the MENU screen of the main unit.

Refer to section 5-6. "LAN (LAN Settings)" in the MV-1600 Operation Manual for the details of setting on the main unit menu screen.

1-3. Notes for the LAN Interface

- 1) IP address, Subnet mask, Gateway and Port number settings must be suitable for your network system.
- 2) Consult your system administrator before setting IP address, Subnet mask, Gateway and Port number to avoid troubles, if configuring the system in the existing LAN.
- 3) The MV-1600 cannot establish connection to multiple PCs over a LAN.
- 4) Release the port at the MV-1600 when terminating the control from the PC, so that the MV-1600 can establish the connection again to the PC or to another PC.
- 5) When releasing the image data receiving port (number 2000), it takes about 10 seconds for the port at the MV-1600 to be released. Communication cannot be established during the period.
- 6) The command port (number 2001) automatically shuts down the socket connection when it does not receive a command for 5 seconds.
- 7) If the security by ID and the password is set, add the data shown below to the beginning of the command line.

Byte	Parameter	Command	Description
1	Number of characters	1 - 8	The number of ID characters.
*	ID characters	ASCII code Alphanumeric only (See table 1 st + 2 nd next page)	ID characters: Up to 8 characters.
*	Password data	0 - 9	First digit
		0 - 9	Second digit
		0 - 9	Third digit
		0 - 9	Fourth digit
		0 - 9	Fifth digit

* Total number of bytes differs depending on the set ID data.

Character Code Table

1 st 2 nd	0	1	2	3	4	5	6	7	8	9	A	B	C	D	E	F
0			SP	0		P										
1				1	A	Q										
2				2	B	R										
3				3	C	S										
4				4	D	T										
5				5	E	U										
6				6	F	V										
7				7	G	W										
8				8	H	X										
9				9	I	Y										
A					J	Z										
B					K											
C					L											
D					M											
E					N											
F					O											

Blank cells are unavailable.

◆ MV-1600 command flow chart

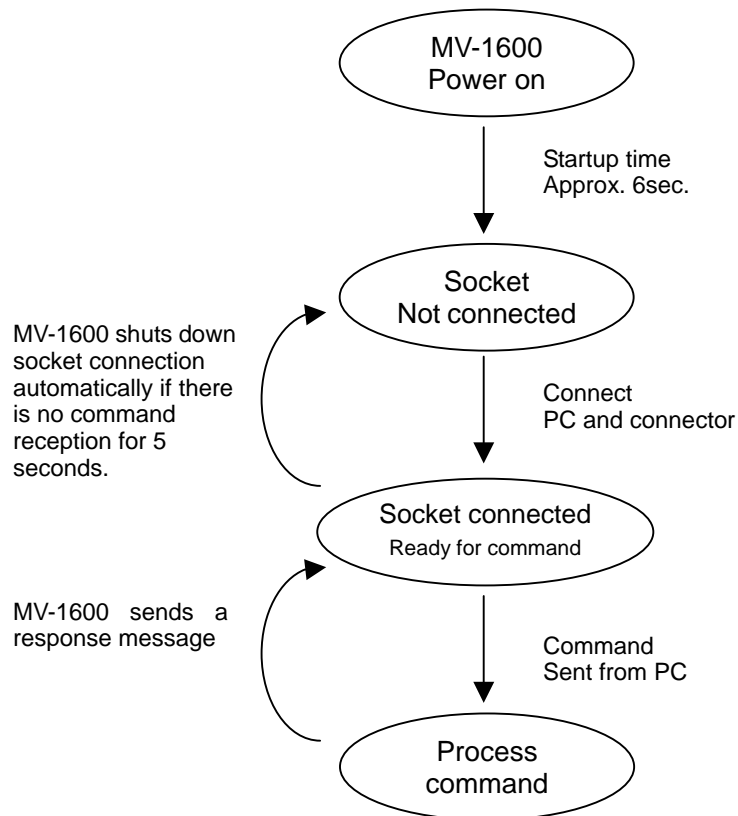

1-4. Command Protocol Format

The command format is shared for LAN and RS-232C interfaces. Commands are issued by the control device as shown below.

All command contents are transmitted and received in ASCII code. Use the specified formats when making and sending message commands. The command format is shown in the table below.

◆ Command Format

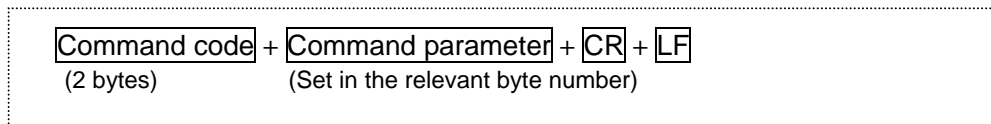

(Works without LF as well)

Ex.: When sending a command to switch channels

Byte	Parameter	Command	Description
1	Command code	S	
2		C	
3-4	Camera channel	01-16	Channel no.: switch to CH1-16
5	End code	CR	
6		LF	

IMPORTANT

The MV-1600 sends a response or message after receiving a command. Do not send the next command before receiving a response or message transmitted by the MV-1600. Otherwise, the command cannot be read properly.

1-5. Response Message Format

After sending commands, you will receive a response messages from the MV-1600.

◆ Normal end

Messages are returned in the format below after normal reception and processing.

Byte	Parameter	Message	Description
1	Message code	O	"OK"
2		K	
3	End code	CR	
4		LF	

Abnormal end

Messages are returned in the format below if something prevents commands from being issued normally.

Byte	Parameter	Message	Description
1	Message code	E	"ERR"
2		R	
3		R	
4	End code	CR	
5		LF	

1-6. Image Data Format for Video Transmission over a LAN Interface

Set frame rate for video transmission by the video transmission frame rate command. The frame rate should be set other than 0fps. 0fps is used to cancel the transmission.

IMPORTANT

The video transmission over a LAN interface is available regardless of the FUNCTION setting. Refer to the section 5-7. "SYSTEM (SYSTEM Settings)" of the MV-1600 Operation manual for details. Refer to section 2-7. "Video Frame Rate Command" for the frame rate command details. The video transmission is available only over a LAN interface. It is not available over a RS-232C interface. The port number for the transmission is "2000."

(1)When ALARM / VIDEO LOSS Data Addition is set to Off

◆ **Image data format**

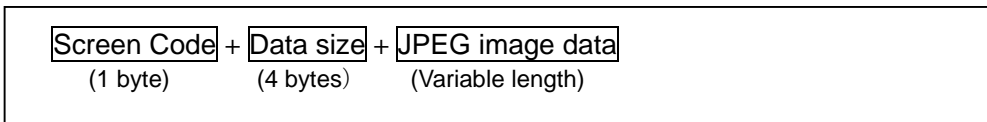

Screen Code: The display mode for the transmitting JPEG image.

Data size: The size of the transmitting JPEG image data. JPEG image data size is the data size of the 6th byte to the last byte.

JPEG Image data: The image data after compression. Data size varies. Refer to the written JPEG standard.

Byte	Parameter	Data	Description
1	Screen code	0x00 - 0x0F	Full screen display of CH1-CH16
		0x20	Quad screen (screen size 640x480pixels)
		0x21	Quad screen (screen size 1280x960pixels)
		0x22	16-split screen (screen size 640x480pixels)
		0x23	16-split screen (screen size 1280x960pixels)
2-5	Data size	0 x XXXXXXXX	Data size of transmitting JPEG image data.
6 : : (data size) +6	JPEG Image data	JPEG data	JPEG image data

IMPORTANT

Image data formats are all in binary data.

(2) When ALARM / VIDEO LOSS Data Addition is set to On

◆ **Image data format**

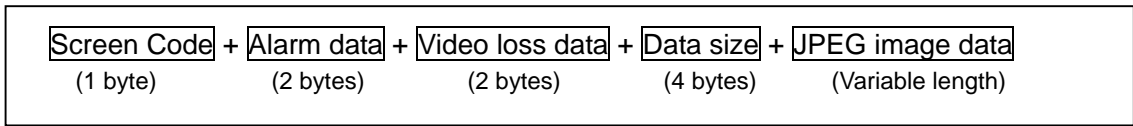

Alarm data: Displays the channel where an alarm signal is received.

Video loss data: Displays the channel where a video loss is occurring.

Byte	Parameter	Data	Description
1	Screen code	0x80 - 0x8F	Full screen display of CH1-CH16
		0xA0	Quad screen (screen size 640x480pixels)
		0xA1	Quad screen (screen size 1280x960pixels)
		0xA2	16-split screen (screen size 640x480pixels)
		0xA3	16-split screen (screen size 1280x960pixels)
2-3	Alarm data	0x0000 - 0xFFFF	Bit No. 0 - 15 Bit value 0: No alarm Bit value 1: Alarm received
4-5	Video loss data	0x0000 - 0xFFFF	Bit No. 0 - 15 Bit value 0: No video loss Bit value 1: Video loss occurring
6-9	Data size	0XXXXXXXX	Data size of transmitting JPEG image data.
10 : : (data size) +10	JPEG Image data	JPEG data	JPEG image data

e.g.) When alarm inputs are received at CH1, CH11 and CH16, the 2nd and 3rd bytes are "0x8401".

Channel	CH 16	CH 15	CH 14	CH 13	CH 12	CH 11	CH 10	CH 9	CH 8	CH 7	CH 6	CH 5	CH 4	CH 3	CH 2	CH 1
Bit No.	15	14	13	12	11	10	9	8	7	6	5	4	3	2	1	0
Bit value	1	0	0	0	0	1	0	0	0	0	0	0	0	0	0	1
Byte value	8				4				0				1			

IMPORTANT

Image data formats are all in binary data. See section 2-10. "Add Data in Image Data Format Command" for the details on ALARM/VIDEO LOSS data settings.

2. Control Commands

2-1. Full Screen Display Command

This is used to display the specified channel in full screen mode.
The response message is "OK" after normal reception and processing.
The "ERR" message is returned during MENU screen display.

Byte	Parameter	Command	Description
1	Command code	S	
2		C	
3-4	Camera channel no.	01-16	Displays channel: CH1-16
5	End code	CR	
6		LF	

2-2. Split Screen Display Command

This is used to display the specified channel in split screen. The last displayed split screen page is displayed for the split screen which has pages.
The response message is "OK" after normal reception and processing.
The "ERR" message is returned during MENU screen display.

Byte	Parameter	Command	Description
1	Command code	S	
2		I	
3	Screen mode	1	Quad screen
		3	9-split screen
		6	16-split screen
4	End code	CR	
5		LF	

IMPORTANT

In quad and 16-split screen, the same channels are displayed in SXGA output, VIDEO output and the video transmission over a LAN interface. When 9-split screen is selected, 9-split screen is displayed in SXGA output, but 16-split screen is displayed in VIDEO output and the video transmission over a LAN interface.

2-3. Change Page Command

This is used to change the split screen page while displaying split screen.

The response message is "OK" after normal reception and processing.

The "ERR" message is returned during MENU screen display, full screen display or 16-split display.

Byte	Parameter	Command	Description
1	Command code	P	
2		S	
3	Split screen page	A - D	Split screen page A to D. * For the 9-split screen, only A and B are available. The "ERR" is returned if C or D is entered.
4	End code	CR	
5		LF	

2-4. Auto Sequencing Start Command

This is used to initiate auto sequencing of the displayed screen.

The response message is "OK" after normal reception and processing.

The "ERR" message is returned during MENU screen display, alarm operation or 16-split display.

Byte	Parameter	Command	Description
1	Command code	A	
2		S	
4	End code	CR	
5		LF	

2-5. Alarm Reset Command

This is used to reset the alarm. However, the external alarm is reset only when the input mode is set to "TRIG."

The response message is "OK" after normal reception and processing.

The "ERR" message is returned during MENU screen display.

Byte	Parameter	Command	Description
1	Command code	A	
2		T	
3	End code	CR	
4		LF	

2-6. Alarm Input Command

This is used to input alarm signal to each channel. However, the external alarm input is enabled only when the input mode is set to "TRIG."

The response message is "OK" after normal reception and processing.

The "ERR" message is returned during MENU screen display or when the external alarm input mode is set to "LEVEL".

Byte	Parameter	Command	Description
1	Command code	A	
2		I	
3-4	Channel no.	01-16	Channel no.: 1-16
5	End code	CR	
6		LF	

2-7. Video Transmission Frame Rate Commands

This is used to set frame rate for the video transmission.

The response message is "OK" after normal reception and processing.

The "ERR" message is returned during MENU screen display.

Byte	Parameter	Command	Description
1	Command code	N	
2		F	
3	Frame rate	0	0fps (No video transmission)
		1	NTSC: 1fps, PAL: 1fps
		2	NTSC: 5fps, PAL: 4fps
		3	NTSC: 10fps, PAL: 8fps
		4	NTSC: 15fps, PAL: 12fps
		5	NTSC: 30fps, PAL: 25fps
6	NTSC: 60fps, PAL: 50fps		
4	End code	CR	
5		LF	

IMPORTANT

Setting a frame rate other than 0fps will start the video transmission. To cancel transmission, set the frame rate to 0fps. The specified frame rate may not be obtained due to JPEG compression ratio, the type of the connected PC or the network environment. In such cases, modify the JPEG compression ratio to reduce transmitting data size. The video transmission is cancelled while the menu screen is open.

2-8. Video Transmission JPEG Compression Ratio Commands

This is used to set video output frame ratio.

The response message is "OK" after normal reception and processing.

The "ERR" message is returned during MENU screen display.

Byte	Parameter	Command	Description
1	Command code	N	
2		J	
3	JPEG compression ratio	0	Low image quality
		1	Average image quality
		2	High image quality
		3	Highest image quality
4	End code	CR	
5		LF	

2-9. Video Transmission Screen Size Command

This is used to set the screen size for the video transmission.

The response message is "OK" after normal reception and processing.

The "ERR" message is returned during MENU screen display.

Byte	Parameter	Command	Description
1	Command code	N	
2		P	
3	JPEG size	0	VGA
		2	SXGA
4	End code	CR	
5		LF	

2-10. Add Data in Image Data Format Command

This is used to set whether to add alarm or video loss data in an image data format.

Byte	Parameter	Command	Description
1	Command code	I	
2		F	
3	ALARM / VIDEO LOSS data addition	0	OFF
		1	ON
4	Reserve	0	
5	Reserve	0	
6	Reserve	0	
7	End code	CR	
8		LF	

3. Status Request Commands

3-1. Version Request Command

This is used to request the version information for the software and hardware of the MV-1600. A [VA] version message is returned after normal reception and processing.

◆ [VR] Request command

Byte	Parameter	Command	Description
1	Command code	V	
2		R	
3	End code	CR	
4		LF	

◆ [VA] Response message

Byte	Parameter	Message	Description
1	Message code	V	
2		A	
3-5	Software version	XXX	Software version (X.XX)
6-9	Hardware version	YYYY	Hardware version (YYYY)
10	End code	CR	
11		LF	

3-2. Video Format Request Command

This is used to request the status of the current VIDEO format. A [FA] output status message is returned after normal reception and processing.

◆ [FR] Request command

Byte	Parameter	Command	Description
1	Command code	F	
2		R	
3	End code	CR	
4		LF	

◆ [FA] Response message

Byte	Parameter	Message	Description
1	Message code	F	
2		A	
3	Video format	0	NTSC
		1	PAL
4	End code	CR	
5		LF	

3-3. Output Status Request Command

This is used to request the status of the current video output.
An [OA] monitor display status message is returned after normal reception and processing.

◆ [OR] Request command

Byte	Parameter	Command	Description
1	Command code	O	
2		R	
3	End code	CR	
4		LF	

◆ [OA] Responce message

Byte	Parameter	Message	Description
1	Message code	O	
2		A	
3	Display mode	0	Standard mode
		1	Alarm display mode
		2	MENU mode
4	Display screen *Fixed to 0 while the MENU is open.	0	Full screen
		1	Quad screen
		3	9-split screen
		6	16-split screen
5	Split screen page	A - D	Split screen page * Quad screen: A - D 9-split Screen A, B In other split screen settings other than quad or 9-split screen, page is always fixed to A.
6	Auto sequencing	0	Auto sequencing OFF
		1	Auto sequencing ON
7-8	Display channel	01-16	Channel no. 1-16 *Fixed to 01 while displaying split screen or menu.
9	End code	CR	
10		LF	

3-4. Alarm Data Request Command

This is used to request the current alarm and video loss data.

Channel numbers are given in hexadecimal.

An [AA] alarm status message is returned after normal reception and processing.

◆ [AR] Request command

Byte	Parameter	Command	Description
1	Command code	A	
2		R	
3	End code	CR	
4		LF	

◆ [AA] Response message

Byte	Parameter	Message	Description
1	Message code	A	
2		A	
3-6	Alarm information	0000–FFFF	Bit no.0-15 Bit value 0: No alarm Bit value 1: Alarm received
7-10	Video loss information	0000–000F	Bit no.0~3 Bit value 0: No video loss Bit value 1: Video loss occurring
11	End code	CR	
12		LF	

Example 1: When alarm inputs are received at CH1, CH11 and CH16, bytes 3–6 are "8401".

Channel no.	CH 16	CH 15	CH 14	CH 13	CH 12	CH 11	CH 10	CH 9	CH 8	CH 7	CH 6	CH 5	CH 4	CH 3	CH 2	CH 1
Bit no.	15	14	13	12	11	10	9	8	7	6	5	4	3	2	1	0
Bit value	1	0	0	0	0	1	0	0	0	0	0	0	0	0	0	1
Byte value	8				4				0				1			

3-5. Fan Alarm Status Request Command

This is used to request the status of the fan alarm.
An [RA] fan alarm status message is returned after normal reception and processing.

◆ [RF] Request command

Byte	Parameter	Command	Description
1	Command code	R	
2		F	
3	End code	CR	
4		LF	

◆ [RA] Response message

Byte	Parameter	Message	Description
1	Message code	R	
2		A	
3	Fan alarm status	0	No fan alarm
		1	Fan alarm
4	End code	CR	
5		LF	

3-6. Video Transmission Status Request Command

This is used to request the current status of the video transmission.

An [NA] fan alarm status message is returned after normal reception and processing.

◆ [NR] Request command

Byte	Parameter	Command	Description
1	Command code	N	
2		R	
3	End code	CR	
4		LF	

◆ [NA] Response message

Byte	Parameter	Message	Description
1	Message code	N	
2		A	
3	Frame rate	0	0fps (No video transmission)
		1	NTSC: 1fps, PAL: 1fps
		2	NTSC: 5fps, PAL: 4fps
		3	NTSC: 10fps, PAL: 8fps
		4	NTSC: 15fps, PAL: 12fps
		5	NTSC: 30fps, PAL: 25fps
		6	NTSC: 60fps, PAL: 50fps
4	JPEG compression ratio	0	Low image quality
		1	Average image quality
		2	High image quality
		3	Highest image quality
5	Screen size	0	VGA
		2	SXGA
6	End code	CR	
7		LF	

3-7. Data Addition in Image Data Format Setting Status Request Command

This is used to request the setting status of alarm or video loss data addition in an image data format.

An "IA" data addition status message is returned after normal reception and processing.

◆ [IR] Request command

Byte	Parameter	Command	Description
1	Command code	I	
2		R	
3	End code	CR	
4		LF	

◆ [IA] Response message

Byte	Parameter	Message	Description
1	Command code	I	
2		A	
3	ALARM / VIDEO LOSS data addition	0	OFF
		1	ON
4	Reserve	0	
5	Reserve	0	
6	Reserve	0	
7	End code	CR	
8		LF	

4. Menu Setting Control

4-1. Command Format

All menu settings are performed using the [MN] command code. Identify each menu by the menu code and specify the settings.

All command contents are transmitted and received in ASCII code. Use the specified formats when making and sending message commands. The command format is shown in the table below.

◆ **Command format**

$\boxed{\text{MN}} + \boxed{\text{Menu code}} + \boxed{\text{Command parameter}} + \boxed{\text{CR}} + \boxed{\text{LF}}$ (2 bytes)(1 byte/see below) (Set in the relevant byte number)
--

(LF can be omitted.)

The menu codes are shown in the table below.

Menu Code	Description	Reference
1	TIME SETUP	"4-2-1"
2	AUTO SEQUENCE	"4-2-2"
3	ALARM/VIDEO LOSS	"4-2-3"
4	TITLE	"4-2-4"
5	DISPLAY	"4-2-5"
6	SYSTEM	"4-2-6"
0	MULTICAST	"4-2-7"

IMPORTANT

The "ERR" message is returned when a setting command is received while MENU screen is open.

4-2. Menu Setting Commands

4-2-1. TIME SETUP Setting Command

This is used to set the parameter for TIME SETUP menu. Enter values in decimal number. The "ERR" message is returned during alarm operations.

Byte	Parameter	Command	Description
1	Command code	M	
2		N	
3	Menu code	1	TIME SETUP setting
4-5	Split screen auto reset time	00-60	00 : OFF, 1-60sec
6-7	Alarm reset time	01-60	1-60sec
8-9	Video loss reset time	01-60	1-60sec
10	End code	CR	
11		LF	

4-2-2. AUTO SEQUENCE Setting Command

This is used to set the parameter for [AUTO SEQUENCE] submenu in [TIME SETUP] menu. The "ERR" message is returned during alarm operations.

Byte	Parameter	Command	Description
1	Command code	M	
2		N	
3	Menu code	2	AUTO SEQUENCE setting
4-5	Split screen auto sequence interval	01-30	1-30sec
6-7	CH1 full screen switching interval	00-30	0-30sec * The channel set to 0 seconds is skipped.
8-9	CH2 full screen switching interval	00-30	
10-11	CH3 full screen switching interval	00-30	
12-13	CH4 full screen switching interval	00-30	
14-15	CH5 full screen switching interval	00-30	
16-17	CH6 full screen switching interval	00-30	
18-19	CH7 full screen switching interval	00-30	
20-21	CH8 full screen switching interval	00-30	
22-23	CH9 full screen switching interval	00-30	
24-25	CH10 full screen switching interval	00-30	
26-27	CH11 full screen switching interval	00-30	
28-29	CH12 full screen switching interval	00-30	
30-31	CH13 full screen switching interval	00-30	
32-33	CH14 full screen switching interval	00-30	
34-35	CH15 full screen switching interval	00-30	
36-37	CH16 full screen switching interval	00-30	
38	End code	CR	
39		LF	

4-2-3. ALARM / VIDEO LOSS Setting Command

This is used to set the parameter for [ALARM/VIDEO LOSS] menu.
The "ERR" message is returned during alarm operations.

Byte	Parameter	Command	Description
1	Command code	M	
2		N	
3	Menu code	3	Alarm/Video loss setting
4	Alarm input mode	0	Trigger input
		1	Level input
5	Alarm display mode	0	FULL
		1	SPLIT
6	Alarm ON/OFF	0	OFF
		1	ON
7	Video loss ON/OFF	0	OFF
		1	ON
8	End code	CR	
9		LF	

4-2-4. TITLE Setting command

This is used to set the parameter for [TITLE] menu.
The "ERR" message is returned during alarm operations.

(1) SXGA Title

Byte	Parameter	Command	Description
1	Command code	M	
2		N	
3	Menu code	4	Title setting
4	Item code	0	SXGA title
5-6	Title setting channel	01-16	Channel no. 1-16
6	Title data	ASCII code (See "Character code table" in the next page)	1st character (from the left)
7			2nd character
8			3rd character
9			4th character
10			5th character
11			6th character
12			7th character
13			8th character
14	End code	CR	
15		LF	

(2) Video Title

Byte	Parameter	Command	Description
1	Command code	M	
2		N	
3	Menu code	4	Title setting
4	Item code	1	Video title
5-6	Title setting channel	01-16	Channel no. 1-16
7	Title data	ASCII code (See "Character code table" below)	1st character (from the left)
8			2nd character
9			3rd character
10			4th character
11			5th character
12			6th character
13	End code	CR	
14		LF	

Character Code Table

1 st 2 nd	0	1	2	3	4	5	6	7	8	9	A	B	C	D	E	F
0			SP	0		P							タ	ミ		
1			!	1	A	Q					。	ア	チ	ム		
2				2	B	R						イ	ツ	メ		
3				3	C	S						ウ	テ	モ		
4				4	D	T					、	エ	ト	ヤ		
5				5	E	U					・	オ	ナ	ユ		
6				6	F	V					ヲ	カ	ニ	ヨ		
7				7	G	W					ア	キ	ヌ	ラ		
8			(8	H	X					イ	ク	ネ	リ		
9)	9	I	Y					ウ	ケ	ノ	ル		
A				:	J	Z					エ	コ	ハ	レ		
B			+		K						オ	サ	ヒ	ロ		
C					L						ヤ	シ	フ	ワ		
D			-		M						ユ	ス	ヘ	ン		
E					N						ヨ	セ	ホ	、		
F			/	?	O						ツ	ソ	マ	。		

Blank cells are unavailable.

4-2-5. DISPLAY Setting Command

This is used to set the parameter for [DISPLAY] menu.

Enter setting values in decimal number.

The "ERR" message is returned during alarm operations.

Byte	Parameter	Command	Description
1	Command code	M	
2		N	
3	Menu code	5	Display setting
4	Title display ON/OFF (SXGA/LAN)	0	OFF
		1	ON
5	Mark display ON/OFF (SXGA/LAN)	0	OFF
		1	ON
6	Tally display ON/OFF (SXGA)	0	OFF
		1	ON
7	Border display ON/OFF (SXGA)	0	WHITE
		1	BLACK
		2	OFF
8	Title display ON/OFF (Video)	0	OFF
		1	Under scan
		2	Over scan
9	Mark display ON/OFF (Video)	0	OFF
		1	ON
10	Border display ON/OFF (Video)	0	WHITE
		1	BLACK
		2	OFF
11	End code	CR	
12		LF	

4-2-6. SYSTEM Setting Command

This is used to set the parameters for [SYSTEM] menu.
The "ERR" message is returned during alarm operations.

Byte	Parameter	Command	Description
1	Command code	M	
2		N	
3	Menu code	6	System setting
4	Switch lock	0	OFF
		1	ON
5	Output mode	0	SXGA output
		1	Video transmission over LAN
		2	SXGA output and Video transmission over LAN
6	REMOTE/ALARM selection	0	ALARM
		1	REMOTE
7	End code	CR	
8		LF	

4-2-7. MULTICAST Setting Command

This is used to set the multicast address and port for [LAN] menu.
 Enter setting values in decimal number.
 The "ERR" message is returned during alarm operations.

Byte	Parameter	Command	Description
1	Command code	M	
2		N	
3	Menu code	0	Multicast address and port setting
*	First octet	224 - 239	First octet setting
	Delimiter	. (dot)	
	Second octet	0 - 255	Second octet setting
	Delimiter	. (dot)	
	Third octet	0 - 255	Third octet setting
	Delimiter	. (dot)	
	Fourth octet	0 - 255	Fourth octet setting
	Delimiter	: (Colon)	
	Port number	1024 - 65535	Port number setting
	End code	CR	
LF			

* The number of data bytes varies depending on set value of address or port.

IMPORTANT

The setting range for the multicast address is from "224.0.1.0" to "239.255.255.255".
 The MULTICAST setting command is not operative via RS-232C interface.

4-3. Menu Setting Status Request Command

4-3-1. TIME SETUP Setting Status Request Command

This is used to request the setting status of Time Setup parameters.
Setting values are given in decimal.

◆ [MR] Request command

Byte	Parameter	Command	Description
1	Command code	M	
2		R	
3	Menu code	1	TIME SETUP setting
4	End code	CR	
5		LF	

◆ [RS] Response message

Byte	Parameter	Message	Description
1	Command code	R	
2		S	
3	Menu code	1	TIME SETUP setting
4-5	Split screen auto reset time	00-60	00: OFF, 1-60 seconds
6-7	Alarm reset time	01-60	1-60 seconds
8-9	Video loss reset time	01-60	1-60 seconds
10	End code	CR	
11		LF	

4-3-2. AUTO SEQUENCE Setting Status Request Command

This is used to request the setting status of Auto Sequence parameters.

◆ [MR] Request command

Byte	Parameter	Command	Description
1	Command code	M	
2		R	
3	Menu code	2	AUTO SEQUENCE setting
4-5	Channel	00 01-16	: Split screen : Channel no. 1 to 16
6	End code	CR	
7		LF	

◆ [RS] Response message

Byte	Parameter	Message	Description
1	Command code	R	
2		S	
3	Menu code	2	AUTO SEQUENCE setting
4-5	Auto sequence interval	00-30	00: OFF, 1-30 seconds
6	End code	CR	
7		LF	

4-3-3. ALARM/VIDEO LOSS Setting Status Request Command

This is used to request the setting status of Alarm/Video Loss parameters.

◆ [MR] Request command

Byte	Parameter	Command	Description
1	Command code	M	
2		R	
3	Menu code	3	Alarm/Video loss setting
4	End code	CR	
5		LF	

◆ [RS] Response message

Byte	Parameter	Message	Description
1	Command code	R	
2		S	
3	Menu code	3	Alarm/Video loss setting
4	Alarm input mode	0	Trigger input
		1	Level input
5	Alarm display mode	0	FULL
		1	SPLIT
6	Alarm ON/OFF	0	OFF
		1	ON
7	Video loss ON/OFF	0	OFF
		1	ON
8	End code	CR	
9		LF	

4-3-4. TITLE Setting Status Request Command

This is used to request the setting status of Title parameters.

◆ [MR] Request command

Byte	Parameter	Command	Description
1	Command code	M	
2		R	
3	Menu code	4	Title setting
4	Item code	0	SXGA title
		1	Video title
5-6	Title display channel	01-16	Channel no.: 1-16
7	End code	CR	
8		LF	

◆ [RS] Response message

(1) SXGA Title

Byte	Parameter	Message	Description
1	Command code	R	
2		S	
3	Menu code	4	Title setting
4	Title data	ASCII code (See section 4-2-4 Title Setting Command, "Character Code Table" for ASCII code)	1st character (from the left)
5			2nd character
6			3rd character
7			4th character
8			5th character
9			6th character
10			7th character
11			8th character
12	End code	CR	
13		LF	

(2) Video Title

Byte	Parameter	Message	Description
1	Command code	R	
2		S	
3	Menu code	4	Title setting
4	Title data	ASCII code (See section 4-2-4 Title Setting Command, "Character Code Table" for ASCII code)	1st character (from the left)
5			2nd character
6			3rd character
7			4th character
8			5th character
9			6th character
10	End code	CR	
11		LF	

4-3-5. DISPLAY Setting Status Request Command

This is used to request the setting status of Display parameters.
The setting values are given in decimal.

◆ [MR] Request command

Byte	Parameter	Command	Description
1	Command code	M	
2		R	
3	Menu code	5	Display setting
4	End code	CR	
5		LF	

◆ [RS] Response message

Byte	Parameter	Message	Description
1	Command code	R	
2		S	
3	Menu code	5	Display setting
4	Title display ON/OFF (SXGA/LAN)	0	OFF
		1	ON
5	Mark display ON/OFF (SXGA/LAN)	0	OFF
		1	ON
6	Tally display ON/OFF (SXGA)	0	OFF
		1	ON
7	Border display ON/OFF (SXGA)	0	WHITE
		1	BLACK
		2	OFF
8	Title display ON/OFF (Video)	0	OFF
		1	Under scan
		2	Over scan
9	Mark display ON/OFF (Video)	0	OFF
		1	ON
10	Border display ON/OFF (Video)	0	WHITE
		1	BLACK
		2	OFF
11	End code	CR	
12		LF	

4-3-6. SYSTEM Setting Status Request Command

This is used to request the setting status of System parameters.

◆ [MR] Request command

Byte	Parameter	Command	Description
1	Command code	M	
2		R	
3	Menu code	6	System settings
4	End code	CR	
5		LF	

◆ [RS] Response message

Byte	Parameter	Message	Description
1	Command code	R	
2		S	
3	Menu code	6	System settings
4	Switch lock	0	OFF
		1	ON
5	Output mode	0	SXGA output
		1	Video transmission over LAN
		2	SXGA output and video transmission over LAN
6	REMOTE/ALARM selection	0	ALARM
		1	REMOTE
7	Fan alarm status	0	No fan alarm
		1	Fan alarm
8-10	Software version	XXX	Software version (X.XX)
11-14	Hardware version	YYYY	Hardware version (YYYY)
15	End code	CR	
16		LF	

4-3-7. MULTICAST Setting Status Request Command

This is used to request the setting status of multicast address and port on [LAN] menu. The setting values are given in decimal.

◆ [MR] Request command

Byte	Parameter	Command	Description
1	Command code	M	
2		R	
3	Menu code	0	Multicast address and port setting
4	End code	CR	
5		LF	

◆ [RS] Response message

Byte	Parameter	Message	Description
1	Command code	R	
2		S	
3	Menu code	0	Multicast address and port setting
*	First octet	224 - 239	First octet setting
	Delimiter	. (dot)	
	Second octet	0 - 255	Second octet setting
	Delimiter	. (dot)	
	Third octet	0 - 255	Third octet setting
	Delimiter	. (dot)	
	Fourth octet	0 - 255	Fourth octet setting
	Delimiter	: (Colon)	
	Port number	1024 - 65535	Port number setting
	End code	CR	
	LF		

* The number of data bytes varies depending on set value of address or port.

IMPORTANT

The MULTICAST setting status request command is not operative via RS-232C interface.

Warning

This equipment has been tested and found to comply with the limits for a Class A digital device, pursuant to Part 15 of FCC Rules. These limits are designed to provide reasonable protection against harmful interference when the equipment is operated in a commercial environment. This equipment generates, uses, and can radiate radio frequency energy and, if not installed and used in accordance with the instruction manual, may cause harmful interference to radio communications. Operation of this equipment in a residential area is likely to cause harmful interference, in which case the user will be required to correct the interference at his own expense.



FOR-A COMPANY LIMITED

Head Office : 3-8-1 Ebisu, Shibuya-ku, Tokyo 150-0013, Japan
Overseas Division Phone: +81 (0)3-3446-3936, Fax: +81 (0)3-3446-1470
Japan Branch Offices : Osaka/Fukuoka/Hiroshima/Nagoya/Sendai/Sapporo
R&D/Production : Sakura Center/Sapporo Center/Florida Center/Los Angeles Center

FOR-A America Corporate Office

11125 Knott Ave., Suite #A, Cypress, CA 90630, U.S.A.
Phone : +1 714-894-3311 Fax : +1 714-894-5399

FOR-A America East Coast Office

1065 Avenue of the Americas Suite #1701A New York, NY 10018, U.S.A.
Phone : +1 212-861-2758 Fax : +1 212-861-2793

FOR-A America Distribution & Service Center

2400 N.E. Waldo Road, Gainesville, FL 32609, U.S.A.
Phone: +1 352-371-1505 Fax : +1 352-378-5320

FOR-A Corporation of Canada

425 Queen Street West, Suite 211, Toronto, Ontario M5V 2A5, CANADA
Phone: +1 416-977-0343 Fax : +1 416-977-0657

FOR-A UK Limited

UNIT C71, Barwell Business Park, Leatherhead Road, Chessington Surrey, KT9 2NY, U.K.
Phone: +44 (0)20-8391-7979 Fax : +44 (0)20-8391-7978

FOR-A Italia S.r.l.

Viale Europa 50 20093, Cologno Monzese (MI), Milan, ITALY
Phone: +39 02-254-3635/6 Fax : +39 02-254-0477

FOR-A Corporation of Korea

801 Dangsang Bld., 53-1 Dangsang-Dong, Youngdeungpo-Gu, Seoul 150-800, Korea
Phone: +82 (0)2-2637-0761 Fax : +82 (0)2-2637-0760

*The contents of this manual are subject to change without notice.