



OPERATION MANUAL

FRAME SYNCHRONIZER **FA-128**
(1ST EDITION-Rev.2)



Precautions

Important Safety Warnings



[Power]

 Caution	Operate unit only on the specified supply voltage.
	Disconnect power cord by connector only. Do not pull on cable portion.
 Stop	Do not place or drop heavy or sharp-edged objects on power cord. A damaged cord can cause fire or electrical shock hazards. Regularly check power cord for excessive wear or damage to avoid possible fire / electrical hazards.



[Grounding]

 Caution	Ensure unit is properly grounded at all times to prevent electrical shock hazard.
 Hazard	Do not ground the unit to gas lines, units, or fixtures of an explosive or dangerous nature.

[Operation]

 Hazard	Do not operate unit in hazardous or potentially explosive atmospheres. Doing so could result in fire, explosion, or other dangerous results.
 Hazard	Do not allow liquids, metal pieces, or other foreign materials to enter the unit. Doing so could result in fire, other hazards, or unit malfunction.
	If foreign material does enter the unit, turn power off and disconnect power cord immediately . Remove material and contact authorized service representative if damage has occurred.

[Circuitry Access]

 Stop	<p>Do not remove covers, panels, casing, or access circuitry with power applied to the unit! Turn power off and disconnect power cord prior to removal. Internal servicing / adjustment of unit should only be performed by qualified personnel.</p>
 Stop	<p>Do not touch any parts / circuitry with a high heat factor. Capacitors can retain enough electric charge to cause mild to serious shock, even after power is disconnected. Capacitors associated with the power supply are especially hazardous. Avoid contact with any capacitors.</p>
 Hazard	<p>Unit should not be operated or stored with cover, panels, and / or casing removed. Operating unit with circuitry exposed could result in electric shock / fire hazards or unit malfunction.</p>

[Potential Hazards]

 Caution	<p>If abnormal smells or noises are noticed coming from the unit, turn power off immediately and disconnect power cord to avoid potentially hazardous conditions. If problems similar to above occur, contact authorized service representative before attempting to again operate unit.</p>
--	---

[Fuse]

 Caution	<p>If this product is equipped with a fuse, fuse replacement should only be performed by qualified personnel. Power off equipment and disconnect power cord prior to replacement. Replace only with fuse of same type, voltage rating, and current rating as specified for the unit.</p>
---	--

[Backup Battery]

 Caution	<p>If this product contains a memory backup battery (either dry cell or rechargeable) and when it is necessary to replace the battery, have work done by the shop where you purchased the product.</p>
--	--

Upon Receipt

Unpacking

FA-128 units and their accessories are fully inspected and adjusted prior to shipment. Operation can be performed immediately upon completing all required connections and operational settings.

Check your received items against the packing lists below.

ITEM	QTY	REMARKS
FA-128	1	
AC Cord	1	
Operation Manual	1	

Option

ITEM	QTY	REMARKS
Rack mount bracket set (type 1)	1 pr.	For single unit mount to a EIA 1RU rack space
Rack mount bracket set (type 2)	1 pr.	For mounting 2 unit to a EIA 1RU rack space

Check

Check to ensure no damage has occurred during shipment. If damage has occurred, or items are missing, inform your supplier immediately.

Table of Contents

1. Prior to Starting	1
1-1. Welcome	1
1-2. About the FA-128	1
1-3. About This Manual	1
2. Panel Descriptions	2
2-1. Front Panel	2
2-2. Rear Panel	4
3. Connection	6
3-1. Basic Connection	6
3-2. GENLOCK Connection	7
4. Operation	8
4-1. Power ON	8
4-2. Front Panel Controls	8
4-3. Front Panel Operations	9
4-3-1. UNITY/OPERATE	9
4-3-2. VIDEO LEVEL	9
4-3-3. CHROMA LEVEL	10
4-3-4. SETUP/BLACK	10
4-3-5. CHROMA PHASE	10
4-3-6. H POSITION	11
4-3-7. SC PHASE	11
4-3-8. H PHASE	12
4-3-9. FREEZE	12
5. Internal Setting	13
5-1. Dipswitch Settings	13
5-1-1. SW5	13
5-1-2. SW6	15
5-1-3. SW7 (NTSC/PAL Settings)	17
5-2. Jumper Settings	18
5-2-1. GENLOCK Setting	18
5-2-2. Factory Default Settings	19
6. If Problems Occur	20
7. Specifications & Dimensions	21
7-1. Unit Specifications	21
7-2. External Dimensions	22
7-2-1. Single Unit Configuration	22
7-2-2. Two Unit Configuration	23

1. Prior to Starting

1-1. Welcome

Congratulations! By purchasing FA-128 you have entered the world of FOR-A and its many innovative products. Thank you for your patronage and we hope you will turn to FOR-A products again and again to satisfy your video and audio needs.

1-2. About the FA-128

Designed by using the latest technology, the FA-128 provides high quality time base correction / frame synchronization performance at a reasonably low cost.

Besides providing the excellent support our customers have come to expect from FOR-A signal processors, that correct by up to one full frame the time base error / phase shift problems that can occur during record / playback of composite signals when using heterodyne process VCRs.

Features

- Analog composite video input / output standard.
- 14-bit digital Y/C separation/decoding/encoding.
- 3 Line Adaptive Comb Filter for high quality decoding of composite sources.
- 4:2:2 digital component signal processing.
- Full frame memory to prevent picture field inversion during processing.
- Compact EIA 1RU half width. Rack mountable with an optional rack mount bracket set.
- 625/50, 525/60, auto detection.

1-3. About This Manual

This manual is intended to help the user easily operate the FA-128 and make full use of its functions during operations. Before connecting or operating your unit, read this operation manual thoroughly to ensure you understand the FA-128. After reading, it is important to keep this manual in a safe place and available for reference.

2. Panel Descriptions

2-1. Front Panel

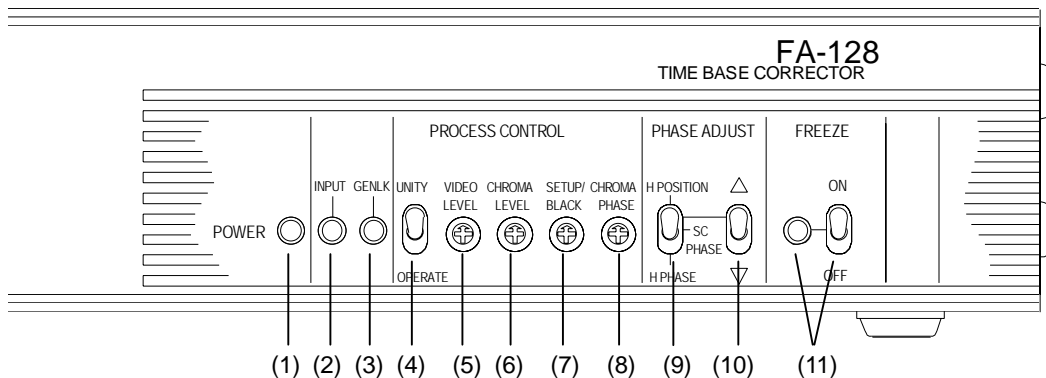

(1) Power indicator

Indicator status	Indication
Lit	Indicates that power is supplied to the system, and the system is operational.
Unlit	Indicates that no power is supplied to the system.
Flashing (Fan Alarm)	Indicates a fan failure occurs in a power supply. Consult your FOR-A supplier.

(2) INPUT indicator

Indicator lights green whenever video signal (s) is inputted to the unit.

Indicator status	Indication
Lit	Receiving video signal input and the unit is working properly.
Unlit	No input video signals. Input level too low Off video random noise.
Flashing	Sync signal is considerably unstable. Sync signal has dropout.

(3) GENLOCK indicator

Indicator lights green whenever FA-128 signal is synced (LOCK) with the external black burst (B.B.) input to the rear panel GENLOCK connector of the module.

Indicator status	Indication
Lit	FA-128 signal synced to external reference signal input.
Unlit	No external reference signal input. Input level too low Internal timing signal used for reference.
Flashing	External reference signal not stable. Check external signal input.

(4) UNITY / OPERATE switch

UNITY	Sets all processes settings for (5), (6), (7), and (8) to UNITY at the same time. (UNITY default setting)
OPERATE	Process controls (5), (6), (7), and (8) at front panel can be used to adjust signal processing parameters.

(5) VIDEO LEVEL

Used to adjust video level.
See sec. "4-3-2. VIDEO LEVEL."

(6) CHROMA LEVEL

Used to adjust chroma level.
See sec. "4-3-3. CHROMA LEVEL."

(7) SETUP / BLACK

Used to adjust setup level.
See sec. "4-3-4. SETUP / BLACK."

(8) CHROMA PHASE

Used to adjust chroma phase.
See sec. "4-3-5. CHROMA PHASE."

(9) SYSTEM PHASE SWITCH

Used to switch between H POSITION, SC PHASE, and H PHASE. Phase is adjusted using (10) PHASE SWITCH.

(10) PHASE SWITCH

Used to adjust phase. See sec. "4-3-6 H POSITION," "4-3-7 SC PHASE," and "4-3-8 H PHASE."

(11) FREEZE and indicator

Used to set freeze operation ON / OFF. Indicator lights green whenever freeze is set to ON. The freeze operation is set to ON when the switch is in the upper position. The operation is set to OFF when set to the lower position.
See sec. "4-3-9. FREEZE."

IMPORTANT

Note that Freeze function doesn't work and the FREEZE indicator blinks if the unit is powered on with the FREEZE switch at upper position (ON). In this case, turn the FREEZE switch at lower position (OFF). The FREEZE indicator light will turn off and the Freeze function will work correctly.

2-2. Rear Panel

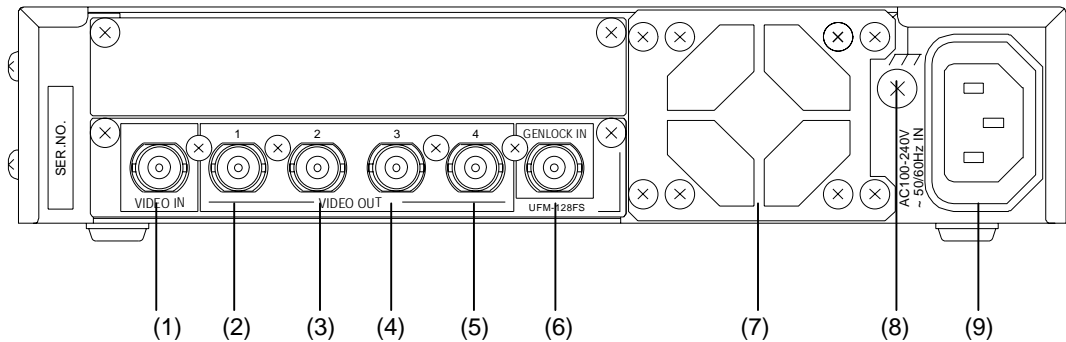

- (1) VIDEO IN
Used for analog composite video input connection.
- (2) VIDEO OUT 1
Used to output the analog composite signal, corrected video input from (1) VIDEO IN, and bypass signal from input connector (1) whenever the unit power is off.
- (3) VIDEO OUT 2
Used to output the analog composite signal, corrected video input from (1) VIDEO IN. Bypass is disabled when the unit power is off.
- (4) VIDEO OUT 3
Used to output the analog composite signal, corrected video input from (1) VIDEO IN. Bypass is disabled when the unit power is off.
- (5) VIDEO OUT 4
Used to output the analog composite signal, corrected video input from (1) VIDEO IN. This can be used for GENLOCK THRU (genlock loopthrough) by using an internal jumper setting. Factory setting is VIDEO OUT 4. Refer to sec. "5-2. Jumper Settings" for more details.
- (6) GENLOCK IN
Used to input an external reference signal whenever the internal sync generator needs to be genlocked with it. The available input signal is 0.429 Vp-p composite black burst (for NTSC) or 0.450 Vp-p composite black burst (for PAL).
Connector (5) can also be used for GENLOCK THRU (genlock loopthrough) by using an internal jumper setting. If connector (5) is set to GENLOCK THRU and is not connected to another system, the connector must be 75 Ω terminated using a terminator prepared by the user. (See sec. "5-2. Jumper Setting.")
Front panel GENLOCK indicator lights green whenever FA-128 signal is synced with external black burst reference signal input here.

- (7) FAN
Used to air cool unit and prevent overheating. Do not block fan intake with other equipment or objects.
- (8) Ground Terminal
Used to ground unit to protect operators against static electricity and / or electrical shock.
- (9) AC IN (AC 100V-240V 50/60Hz)
Used for connection to AC power source via supplied accessory cord.

IMPORTANT

The unit circuitry does not have fuse protection. The unit power cord must not be connected directly to the power source. Instead, use one of the following methods.

- ◆ Connect to a power connection unit having an installed fuse.
- ◆ Connect to a power connection unit having a breaker that can be easily reached in an emergency.

3. Connection

 <p>CAUTION</p>	Turn all the power OFF before making connection.
---	--

3-1. Basic Connection

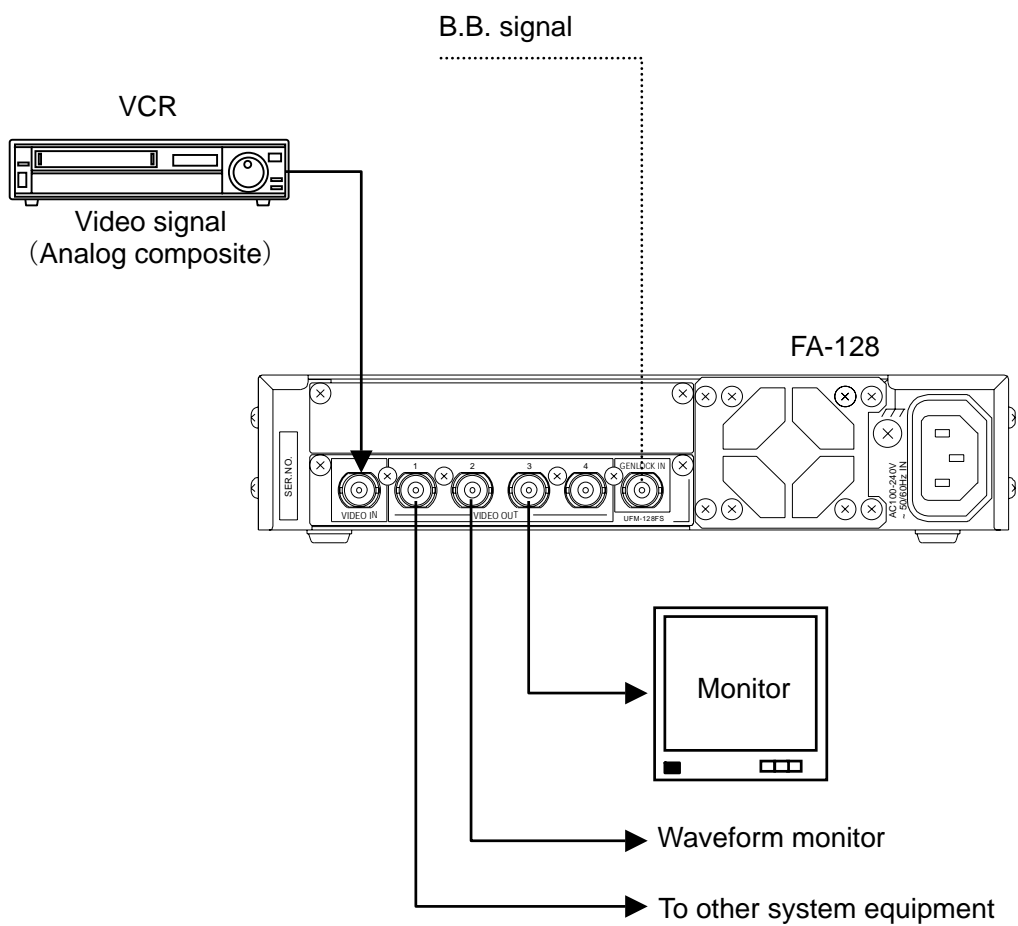

3-2. GENLOCK Connection

If output connector (5) on the rear panel is switched from VIDEO OUT 4 (See sec."2-2. Rear Panel.") to GENLOCK THRU, multiple units can be configured as shown in the figure below. (See sec."5-2. Jumper Setting.")

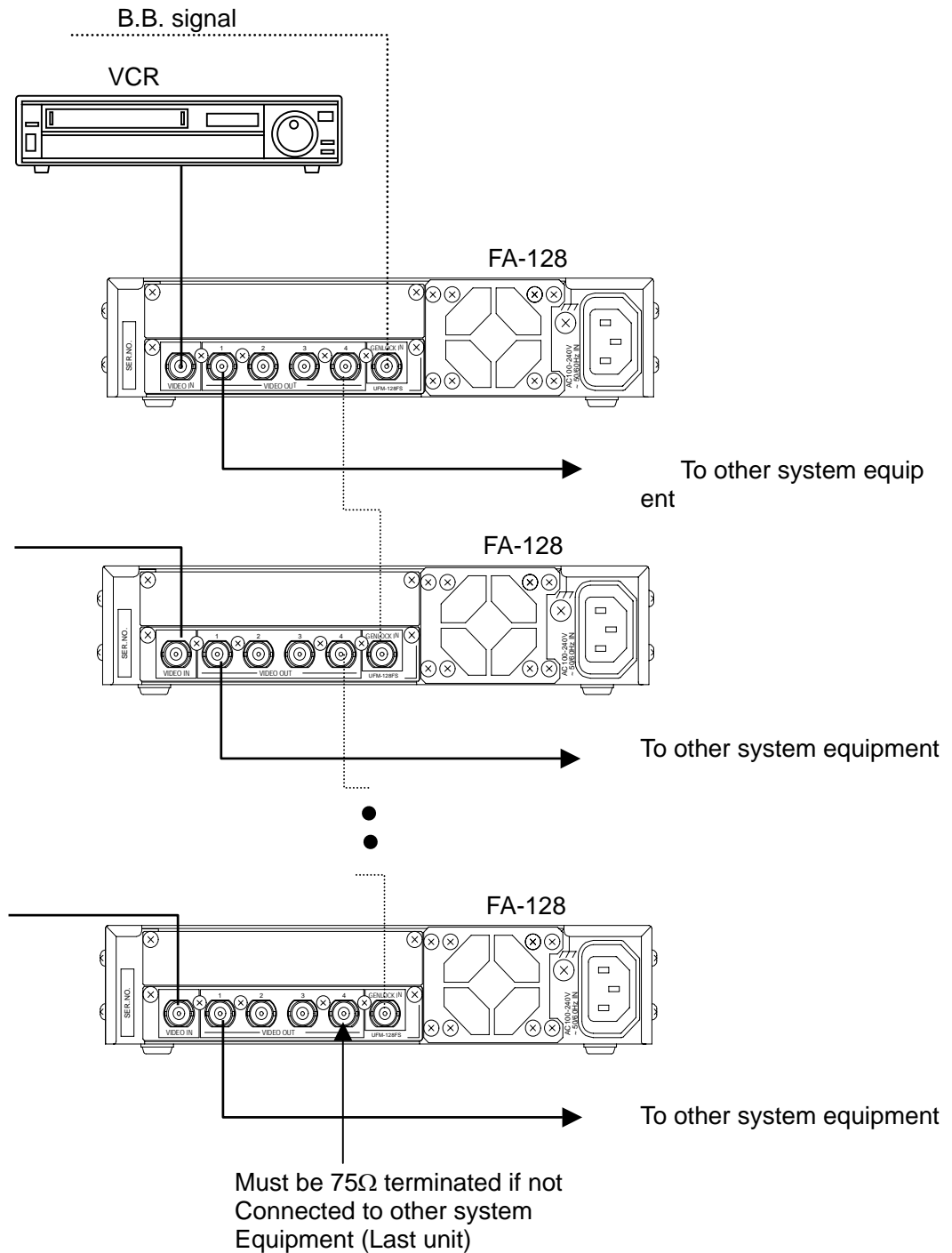

4. Operation

4-1. Power ON

Turn Power switch to ON after all system connections are complete. When the unit is powered ON, the green Power LED should go on. If the video signal is input to the unit, the Input LED shown below will turn on. If the reference signal is input to the unit, the Genlock LED shown below will turn on.

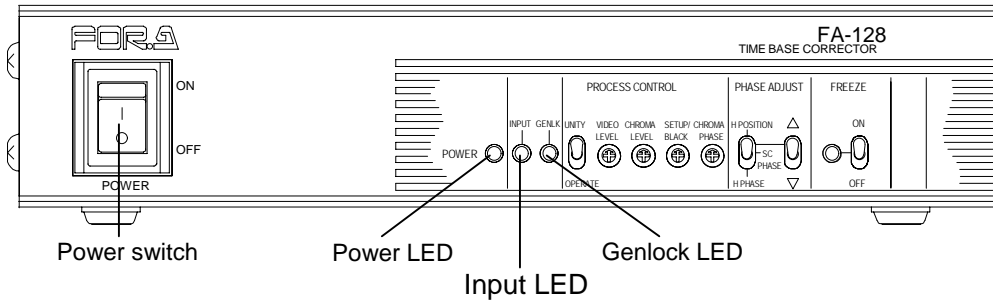

4-2. Front Panel Controls

The FA-128 front panel controls can be used to select and change operational settings and levels and to make settings in the operational menus.

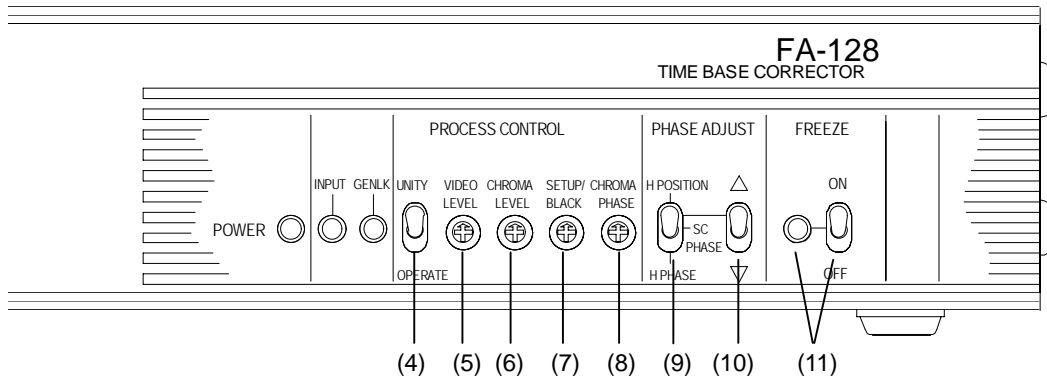

Switch and Controls	Factory Set Default	Reference
(4) UNITY/OPERATE	UNITY	4-3-1
(5) VIDEO LEVEL	CENTER	4-3-2
(6) CHROMA LEVEL	CENTER	4-3-3
(7) SETUP/BLACK	CENTER	4-3-4
(8) CHROMA PHASE	CENTER	4-3-5
(9) H POS / SC PHS / H PHS SELECT	H POS	4-3-6,7,8
(10) PHASE CONTROL	CENTER	4-3-6,7,8
(11) FREEZE	OFF	4-3-9

4-3. Front Panel Operations

4-3-1. UNITY/OPERATE

Set the switch to the upper or lower positions to switch between UNITY and OPERATE.

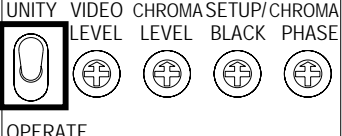
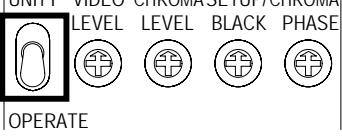
Switch and Controls		Description
Upper position (UNITY)	<p style="text-align: center;">PROCESS CONTROL</p> <p>UNITY VIDEO CHROMA SETUP/CHROMA LEVEL LEVEL BLACK PHASE</p>  <p style="text-align: center;">OPERATE</p>	All process control settings are disabled and return to the default settings.
Lower position (OPERATE)	<p style="text-align: center;">PROCESS CONTROL</p> <p>UNITY VIDEO CHROMA SETUP/CHROMA LEVEL LEVEL BLACK PHASE</p>  <p style="text-align: center;">OPERATE</p>	<p>Following process controls will be enabled:</p> <p>VIDEO LEVEL CHROMA LEVEL SETUP/BLACK CHROMA PHASE</p>

4-3-2. VIDEO LEVEL

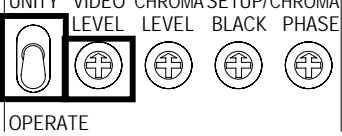
Switch and Control		Description
UNITY/OPERATE: Lower position (OPERATE)	<p style="text-align: center;">PROCESS CONTROL</p> <p>UNITY VIDEO CHROMA SETUP/CHROMA LEVEL LEVEL BLACK PHASE</p>  <p style="text-align: center;">OPERATE</p>	Adjusts output level. Setting range: -3 dB to +3 dB
Turn the VIDEO LEVEL control to adjust		

4-3-3. CHROMA LEVEL

Switch and Control		Description
UNITY/OPERATE: Lower position (OPERATE)		Adjusts chroma level (color saturation). Setting range: -3 dB to +3 dB
Turn the CHROMA LEVEL control to adjust		

4-3-4. SETUP/BLACK

Switch and Control		Description
UNITY/OPERATE: Lower position (OPERATE)		Adjusts setup black level. Turning the control clockwise brightens the setup black. Setting range: -15 IRE to +15 IRE
Turn the SETUP/BLACK control to adjust.		

4-3-5. CHROMA PHASE

Switch and Control		Description
UNITY/OPERATE: Lower position (OPERATE)		Adjusts chroma phase. Setting range: -30° to +30°
Turn the CHROMA PHASE control to adjust.		

4-3-6. H POSITION

Switches		Description
PHASE ADJUST: Upper position (H POSITION)		Used to adjust the H POSITION. Setting range: -2.0 μ sec to +2.0 μ sec * V POSITION can also be adjusted by using an internal dipswitch setting. See sec."5-1-2. SW6." Setting range: -128 Line to +127 Line
Move the PHASE switch (right) upward or downward position.		

IMPORTANT

H POSITION is set to 0 μ sec and V POSITION is set to 0 Line at factory shipment. You should reset this parameter to match the configuration of your system. Note that it takes approximately 1 second until the new setting takes effect. When turning the unit OFF, wait at least 1 second after the setting.

4-3-7. SC PHASE

Switches		Description
PHASE ADJUST: Center position (SC PHASE)		Used to adjust the SC phase difference between the genlock input and video output signals. Upward: Moves SC phase clockwise. Downward: Moves SC phase counterclockwise. Setting range: -180° to +180° (Factory default: 0 μ s)
Move the PHASE switch (right) upward or downward position.		

IMPORTANT

SC PHASE is set to 0° at factory shipment. You should reset this parameter to match the genlock input signal of your system. Note that it takes approximately 1 second until the new setting takes effect. When turning the unit OFF, wait at least 1 second after the setting.

4-3-8. H PHASE

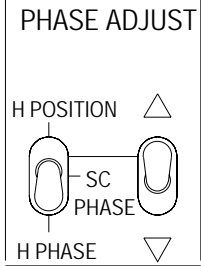
Switches	Description
PHASE ADJUST: Lower position (H PHASE)	
Move the PHASE switch (right) upward or downward position.	
	Used to adjust the H phase difference between the genlock input and video output signals. Upward: Moves H phase forward. Downward: Moves H phase backward. Setting range: -2.0 μ s to +2.0 μ s (Factory default: 0 μ s)

IMPORTANT

H PHASE is set to 0 μ s at factory shipment. You should reset this parameter to match the genlock input signal of your system. Note that it takes approximately 1 second until the new setting takes effect. When turning the unit OFF, wait at least 1 second after the setting.

4-3-9. FREEZE

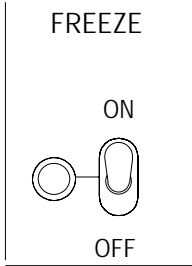
Switch	Description		
	Sets FREEZE mode ON/OFF. Left indicator lit green when FREEZE ON. FRAME or FIELD freeze can be set.		
	<table border="1"> <tr> <td> FRAME FREEZE FRAME freeze gives a clearer picture if the video contains few moving elements. </td> <td> FIELD FREEZE FIELD freeze gives a picture with fewer jitters if the video contains rapid moving elements. </td> </tr> </table>	FRAME FREEZE FRAME freeze gives a clearer picture if the video contains few moving elements.	FIELD FREEZE FIELD freeze gives a picture with fewer jitters if the video contains rapid moving elements.
	FRAME FREEZE FRAME freeze gives a clearer picture if the video contains few moving elements.	FIELD FREEZE FIELD freeze gives a picture with fewer jitters if the video contains rapid moving elements.	
FRAME/FIELD is selected by using the internal dipswitch settings. Factory default is FRAME. See sec. "5-1-1. SW5." ODD or EVEN field can be selected when using the FIELD setting. This is done using the internal dipswitch settings. See sec. "5-1-1. SW5."			

5. Internal Setting

5-1. Dipswitch Settings

Following settings can be made at dipswitch SW5, SW6, and SW7 on the MAIN CARD.

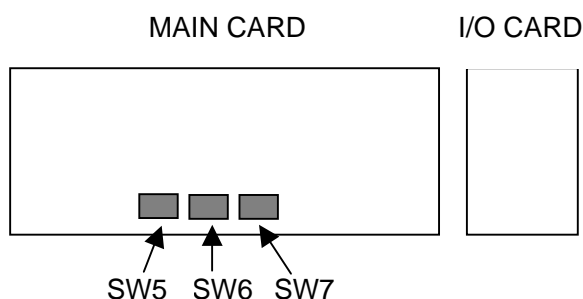

5-1-1. SW5

Dipswitch SW5

Pin No.	Item	Setting	
		OFF	ON
1	BY-PASS	OPERATE	BY-PASS
2	TEST SIGNAL	—	COLOR BAR
3	FREEZE MODE SELECT	FRAME	FIELD
4	FIELD SELECT	ODD	EVEN
5	AUTO FREEZE	OFF	ON
6	FORCED FIELD	OFF	ON
7	B/W	OFF	ON
8	VITS	OFF	ON

*Shaded cells indicate factory default.

◆ **BY-PASS (SW5-1)**

Enables bypass mode. If enabled, input signal routes to VIDEO OUT 1 with no processing.

◆ **TEST SIGNAL (SW5-2)**

Sets internal color bar ON/OFF.

◆ **FREEZE MODE SELECT (SW5-3)**

Used to select FRAME or FIELD freeze.

◆ **FIELD SELECT (SW5-4)**

Used to select ODD or EVEN field when FIELD freeze is set with SW5-3.

◆ **AUTO FREEZE (SW5-5)**

Sets AUTO FREEZE ON/OFF.

Used to freeze last received normal field of video input signal to compensate for input dropout due to signal loss.

NOTE

Off video random noise is considered to be signal loss.

Once the video is frozen, freeze mode is not released until a normal video input is received or AUTO FREEZE is set to OFF.

◆ **FORCED FIELD (SW5-6)**

Used to select half frame output ON/OFF.

When set to ON, either the ODD or EVEN field will be output from the VIDEO OUT connector on the rear panel. ODD/EVEN is selected with SW5-4.

◆ **B/W (SW5-7)**

Used to select B/W or color video output from rear panel VIDEO OUT connectors.

ON: Black and white video output.

OFF: Color video output.

NOTE

B/W video is output when set to ON even if color video signals are input. In this case, the B/W video output still contains the color burst signal.

◆ **VITS (SW5-8)**

ON:

If VITS signal is included in the input video, it is also included in the output signals. (Inserted to 10 H to 21 H vertical blanking interval)

OFF:

No VITS signal is included in output signals. Vertical blanking interval is 10 H to 20 H.

5-1-2. SW6

Dipswitch SW6

Pin No.	Item	Setting	
		OFF	ON
1	REMOTE	LOCAL	REMOTE
2	SET UP	OFF	ON
3	SYNCHRO MODE	FRAME	LINE
4	WHITE CLIP 110%	OFF	ON
5	FACTORY SETTING	—	—
6	FACTORY SETTING	—	—
7	ACC	OFF	ON
8	VIDEO PHASE SEL	H POSITION	V POSITION

*Shaded cells indicate factory default.

◆ REMOTE (SW6-1)

Used to select remote control. If set to ON(REMOTE), front panel control cannot be used.

◆ SET UP (SW6-2)

Set to ON when processing the input video signal with setup. (US mode)

◆ SYNCHRO MODE (SW6-3)

If set to ON (LINE), input video signal is synchronized to external reference signal by adjusting the horizontal timing to minimize the input/output delay. In this case, the delay will be within the range of 1 H to 3 H as seen in the table below.

Input Video	Genlock Delay	Output Video Delay
Composite (NTSC)	4 μ s or more	Genlock delay + 1H
	Less than 4 μ s	Genlock delay + 2H
Composite (PAL)	5 μ s or more	Genlock delay + 2H
	Less than 5 μ s	Genlock delay + 3H

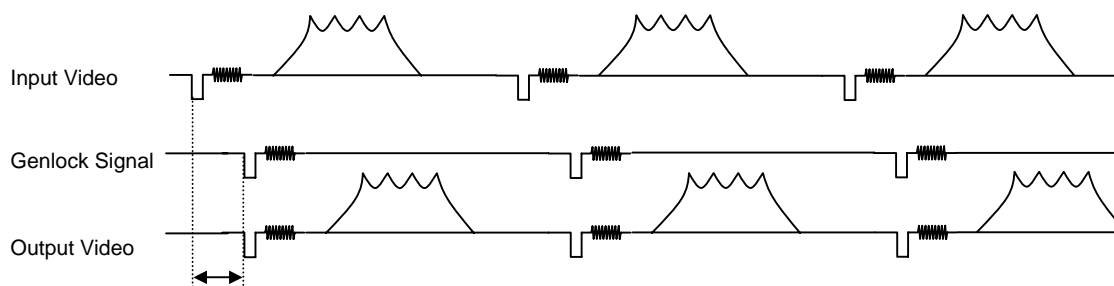

IMPORTANT

When the system is operated in the LINE mode (SYNCHRO MODE to ON), a reference signal previously synchronized with the input video must be used. If not, the POWER lamp will blink and a malfunction may occur.

◆ **WHITE CLIP 110% (SW6-4)**

Used to set the WHITE threshold of the input signal at 110%.

◆ **ACC (AUTO CHROMA CONTROL) (SW6-7)**

Enables automatic chroma level control. Setting range: 50% to 200%

◆ **VIDEO PHASE SEL (SW6-8)**

H POSITION:

When the PHASE ADJUST selection switch is set to H POS position, H POSITION can be adjusted using PHASE switch (right).

V POSITION:

When the PHASE ADJUST selection switch is set to V POS position, V POSITION can be adjusted using PHASE switch (right).

◆ **FACTORY SETTING**

Do not change this setting.

5-1-3. SW7 (NTSC/PAL Settings)

Dipswitch SW7

Pin No.	Item	Setting	
		OFF	ON
1	N / P DETECT MODE	AUTO	MANUAL
2	FORMAT DETECT SEL	INPUT	REF
3	NTSC / PAL SEL	NTSC	PAL
4	FACTORY SET	—	—
5	FACTORY SET	—	—
6	FACTORY SET	—	—
7	FACTORY SET	—	—
8	FACTORY SET	—	—

*Shaded cells indicate factory default.

◆ NTSC / PAL DETECT MODE (SW7-1)

AUTO:

Automatically detects NTSC or PAL using the reference signal selected at FORMAT DETECT SEL (SW7-2).

MANUAL:

Sets to select the video standard manually. NTSC or PAL should be selected at FORMAT DETECT SEL (SW7-3).

◆ FORMAT DETECT SEL (SW7-2)

Selects a signal used for NTSC/PAL automatic detection from following two signals.

*Effective only when SW7-1 is set to AUTO.

INPUT: Input video signal (composite video)

REF: External reference signal (genlock)

◆ NTSC / PAL SELECT (SW7-3)

Used to select video standard.

*Effective only when SW7-1 is set to MANUAL.

◆ FACTORY SET

Do not change this setting.

5-2. Jumper Settings

The following settings can be made at the jumpers on MAIN CARD inside the FA-128.

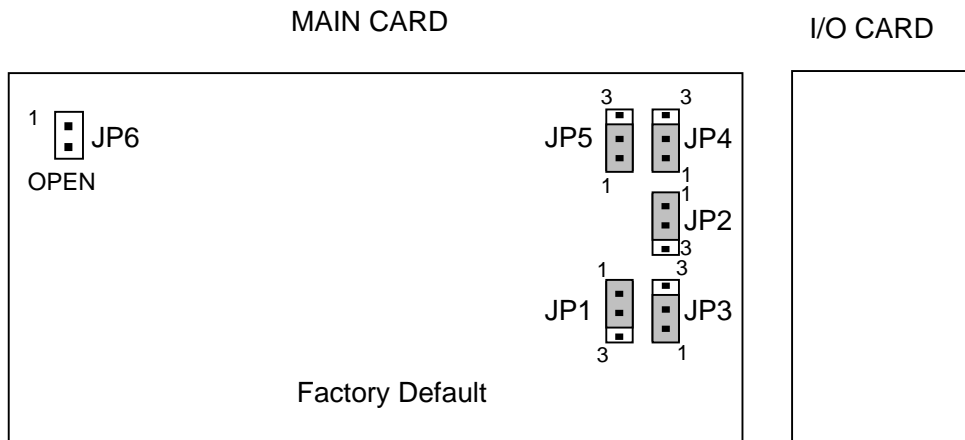

5-2-1. GENLOCK Setting

Jumper JP3 is used to select VIDEO OUT 4 /GENLOCK THRU . Jumper JP1 is used to select GENLOCK termination ON/OFF. The related circuitry for user-fabricated control devices as shown below.

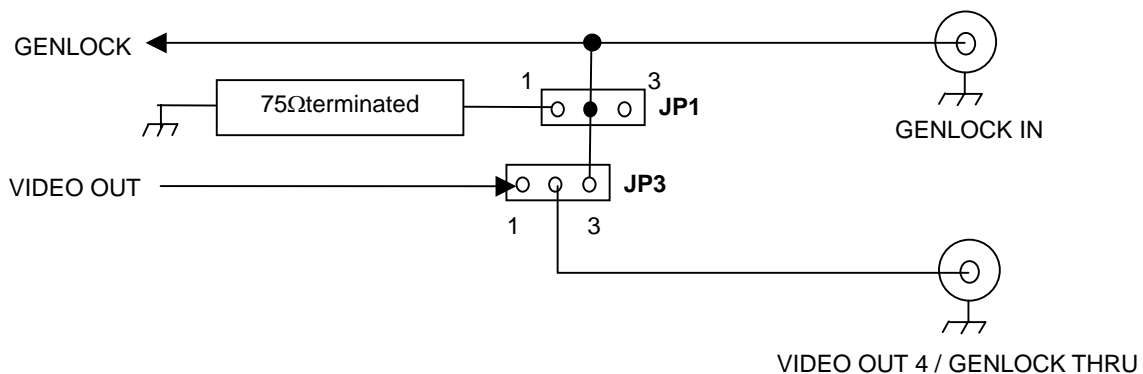

◆ VIDEO OUT 4, GENLOCK terminated set

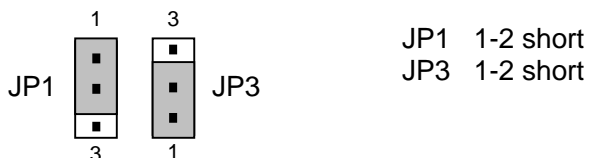

◆ GENLOCK THRU, GENLOCK not terminated set

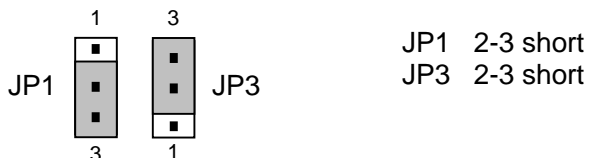

NOTE

If set to GENLOCK THRU, termination cannot be set.

5-2-2. Factory Default Settings

If the jumper settings are changed by mistake, refer to the table below to return them to the default settings.

JP NO.	Setting
JP1	1-2 short
JP2	1-2 short
JP3	1-2 short
JP4	1-2 short
JP5	1-2 short
JP6	Open

Do not change the settings in the shaded sections of the table above from their default settings.

6. If Problems Occur

If any of the following problems occur during operation of your unit, proceed as indicated below to see if problem can be corrected before assuming a unit malfunction has occurred.

Problem	Check	Action
Cannot use process controls	UNITY / OPERATE switch	If UNITY (upper), move the switch to OPERATE (lower) position. See sec. "2-1. Front Panel."
Input video signal not bypassed when power OFF.	VIDEO OUT connection (rear panel)	Only VIDEO OUT1 has bypass capability. See sec. "2-2. Rear Panel."
Output video B/W (color signal input)	B/W setting (dipswitch)	If ON, change to OFF. See sec. "5-1-1. SW5."
Output video frozen, FREEZE not set to ON	Verify video signal is input to VIDEO IN connector.	Verify video signal is input properly. See sec. "2-2. Rear Panel."
	AUTO FREEZE setting (dipswitch)	If ON, and signal has dropout or has been lost, freeze frame will be output. See sec. "5-1-1. SW5."
No output signal from VIDEO OUT 4 connector.	VIDEO OUT 4 / GENLOCK THRU setting (jumper setting)	If GENLOCK THRU, change to VIDEO OUT 4 See sec."5-2. Jumper Setting."
POWER lamp flashing	SYNCHRO MODE setting (dipswitch setting)	Input signal and reference signal are not synchronized. If SYNCHRO MODE is set to ON (LINE), set to OFF (FRAME).

7. Specifications & Dimensions

7-1. Unit Specifications

Standard	525/60 (NTSC) , 625/50 (PAL)
Signal Processing	4:2:2 component
Correction Range	2 field (field inversion prevented)
Sampling Frequency	Y: 13.5MHz、 C: 6.75MHz
Quantization	Internal Processing 14-bit (A/D, D/A)
Video Input	Analog composite : 1.0 Vp-p, 75Ω, 1 ea., BNC
Video Outputs	Analog composite : 1.0 Vp-p, 75Ω, 4 ea., BNC
Genlock Input	Composite B.B 0.429 Vp-p (NTSC) , 0.450 Vp-p (PAL) , 75Ω or loopthrough, 1 ea., BNC. Genlock loopthrough connector of last unit in connection line must be 75Ω terminated.
Input composite signal:	
Frequency Response	(NTSC) 100 kHz–4.2 MHz : -0.5 dB to +0.5 dB 4.2 MHz–5.0 MHz: -1 dB to +1 dB roll off above 5MHz (PAL) 100 kHz–5.0 MHz : -0.5 dB to +0.5 dB 5.0 MHz–5.5 MHz: -1 dB to +1 dB roll off above 5.5MHz
S/N Ratio	60dB or higher
DG/DP	1 % / 1 ° (ALP50%)
K Factor (2T pulse)	1 % or less
H/V Tilt	1 % or less
Residual Jitter	Y: ±15 ns C: ±2°
F _{SC} pull-in range	-300 Hz to +300 Hz (video input) -100Hz to +100Hz (genlock)
Process Control Adjust	Video level: -3dB to +3dB Chroma level: -3dB to +3dB Setup/Black: -15 IRE to 15 IRE Chroma phase: -30° to +30°
Genlock phase control	
SC phase	360°
H phase	-2 μsec to +2 μsec
H position	-2 μsec to +2 μsec
V position	-128 line to +127 line
Temperature	10°C – 40°C
Humidity	30% – 90% (no condensation)
Power	AC 100V – 240V ±10 % 50/60Hz
Consumption	Approx. 22VA (16W) at 100 to 120 VAC
Dimensions	212 (W) x 44 (H) x 350 (D) mm
Weight	Approx. 2.5 kg

7-2. External Dimensions

7-2-1. Single Unit Configuration

(All dimensions in mm)

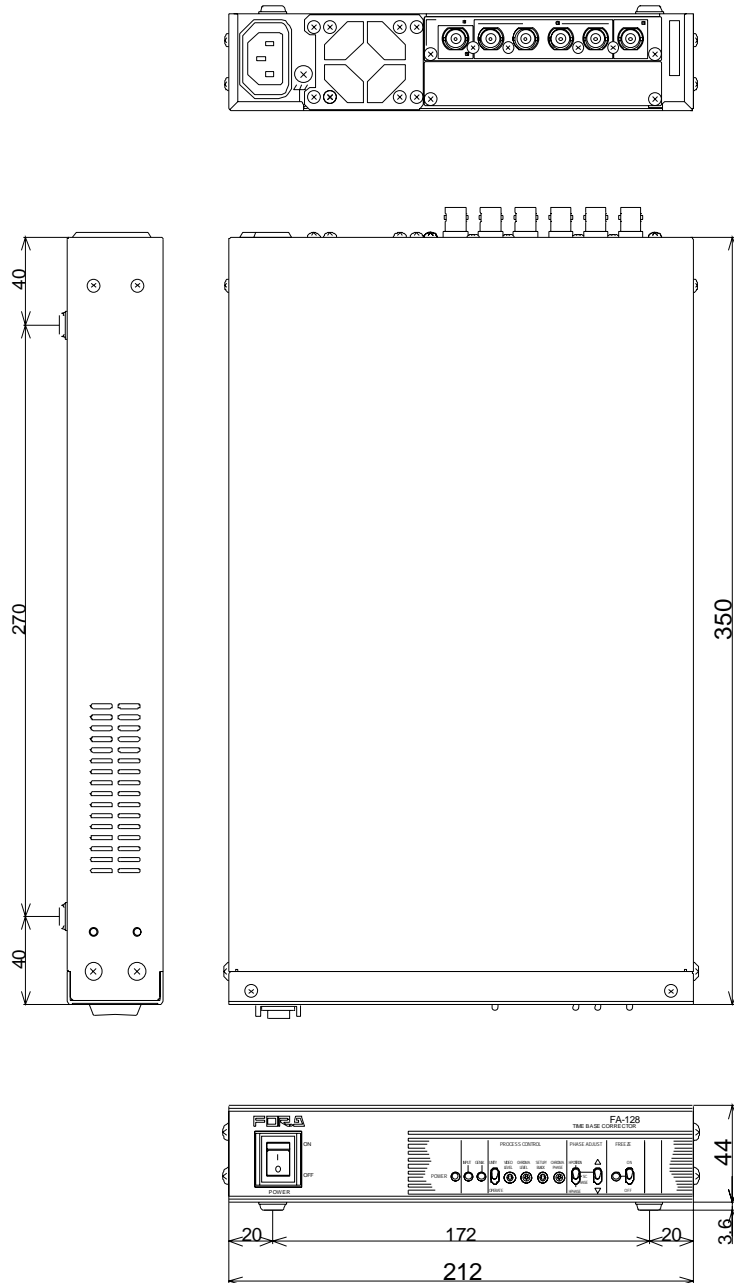

7-2-2. Two Unit Configuration

(All dimensions in mm)

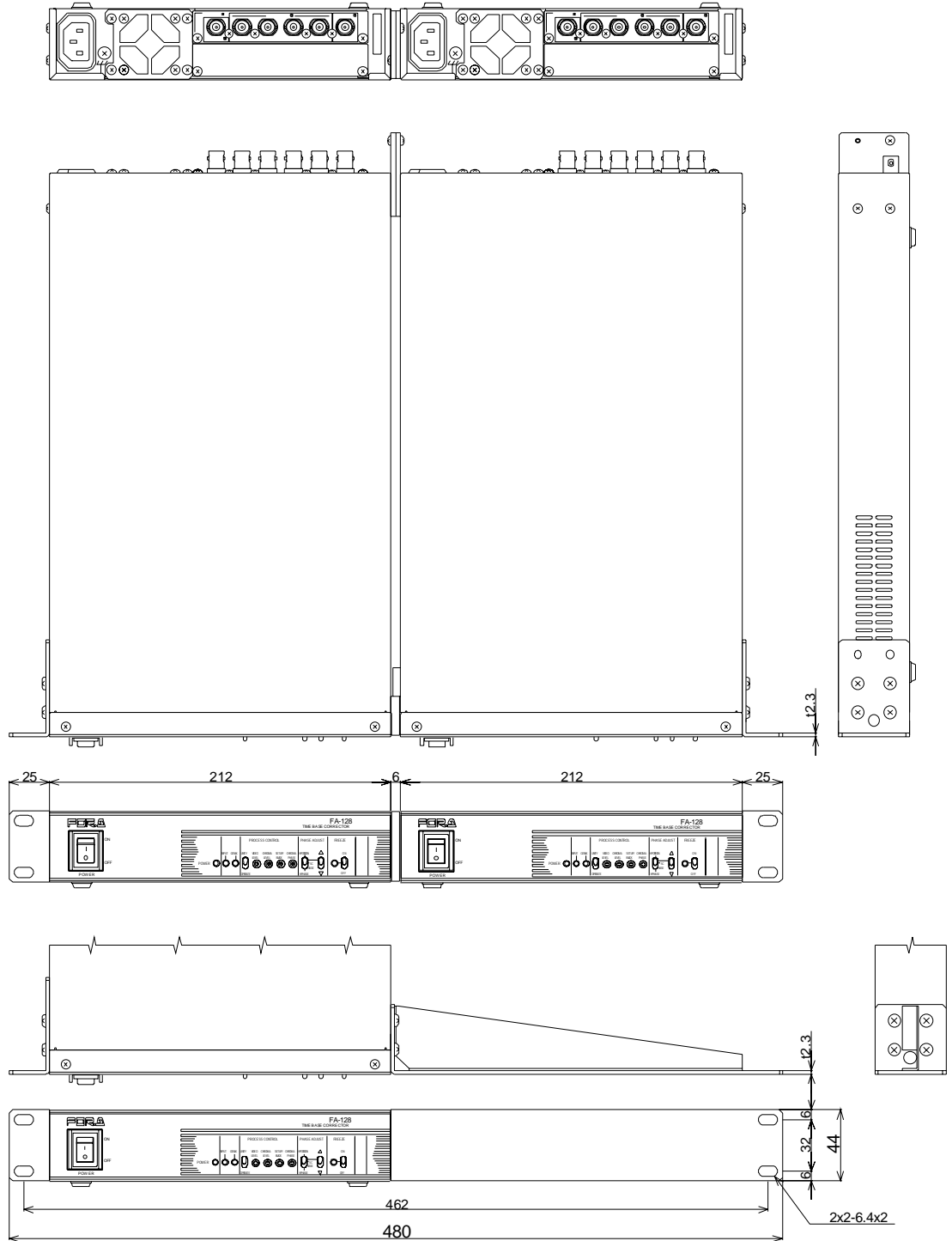

Warning

This equipment has been tested and found to comply with the limits for a Class A digital device, pursuant to Part 15 of FCC Rules. These limits are designed to provide reasonable protection against harmful interference when the equipment is operated in a commercial environment. This equipment generates, uses, and can radiate radio frequency energy and, if not installed and used in accordance with the instruction manual, may cause harmful interference to radio communications. Operation of this equipment in a residential area is likely to cause harmful interference, in which case the user will be required to correct the interference at his own expense.



FOR-A COMPANY LIMITED

Head Office : 3-8-1 Ebisu, Shibuya-ku, Tokyo 150-0013, Japan
Overseas Division Phone: +81 (0)3-3446-3936, Fax: +81 (0)3-3446-1470
Japan Branch Offices : Osaka/Okinawa/Fukuoka/Hiroshima/Nagoya/Sendai/Sapporo
R&D/Production : Sakura Center/Sapporo Center

FOR-A America Corporate Office

11125 Knott Ave., Suite #A, Cypress, CA 90630, USA
Phone: +1 714-894-3311 Fax: +1 714-894-5399

FOR-A America East Coast Office

Two Executive Drive, Suite 670, Fort Lee Executive Park, Fort Lee NJ 07024, USA
Phone: +1 (201) 944-1120 Fax : +1 (201) 944-1132

FOR-A America Distribution & Service Center

2400 N.E. Waldo Road, Gainesville, FL 32609, USA
Phone: +1 352-371-1505 Fax: +1 352-378-5320

FOR-A Corporation of Canada

346A Queen Street West, Toronto, Ontario M5V 2A2, Canada
Phone: +1 416-977-0343 Fax: +1 416-977-0657

FOR-A Latin America & the Caribbean

5200 Blue lagoon Drive,
Suite 760, Miami, FL 33126, USA
Phone: +1-305-931-1700 Fax: +1-305-264-7890

FOR-A UK Limited

UNIT C71, Barwell Business Park, Leatherhead Road, Chessington Surrey, KT9 2NY, UK
Phone: +44 (0)20-8391-7979 Fax: +44 (0)20-8391-7978

FOR-A Italia S.r.l.

Viale Europa 50 20093, Cologno Monzese (MI), Milan, Italy
Phone: +39 02-254-3635/6 Fax: +39 02-254-0477

FOR-A Corporation of Korea

801 Dangsang Bld., 53-1 Dangsang-Dong, Youngdeungpo-Gu, Seoul 150-800, Korea
Phone: +82 (0)2-2637-0761 Fax: +82 (0)2-2637-0760

FOR-A China Limited

708B Huateng Building, No. 302, 3 District, Jinsong, Chaoyang, Beijing 100021, China
Phone: +86 (0)10-8721-6023 Fax: +86 (0)10-8721-6033